

Description

The SY205228DWC is a low-capacitance transient voltage suppressor (TVS) designed to provide electrostatic discharge (ESD) protection for high-speed data interfaces. With typical capacitance of 25pF, the SY205228DWC is designed to protect parasitic-sensitive systems against over-voltage and over-current transient events. It complies with IEC 61000-4-2 (ESD) ($\pm 30\text{kV}$ air, $\pm 30\text{kV}$ contact discharge), IEC 61000-4-5 (Surge) (7.5A, 8/20 μs), etc.

The SY205228DWC uses ultra-small DFN1.0x0.6-2 package. Each SY205228DWC device can protect one data line. It offers system designers flexibility to protect single data line where space is a premium concern.

Features

- Transient Protection for High-speed Data Lines
 - IEC 61000-4-2 (ESD) $\pm 30\text{kV}$ (Air) $\pm 30\text{kV}$ (Contact)
 - IEC 61000-4-5 (Surge) 7.5A (8/20 μs)
- Package Optimized for High-speed Lines
- Ultra-small Package (1.0mmx0.6mmx0.55mm)
- Protects One Data, Control or Power Line
- Low Capacitance: 25pF (Typical)
- Low Leakage Current: 0.01 μA @ V_{RWM} (Typical)
- Low Clamping Voltage
- Each I/O Pin can Withstand Over 1000 ESD Strikes for $\pm 8\text{kV}$ Contact Discharge

Applications

- Desktops, Servers and Notebooks
- Cellular Phones
- MP3 Ports
- Digital Camera Ports

Mechanical Characteristics

- DFN1.0x0.6-2 Package
- Marking: Part Number
- Packaging: Tape and Reel

Circuit Diagram



Ordering Information

Part Number	Package Type	Top Mark
SY205228DWC	DFN1.0x0.6-2 RoHS Compliant and Halogen Free	EW

Pinout (Top View)

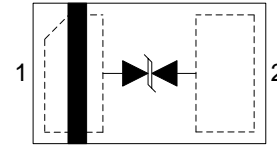

Marking Codes

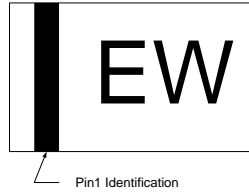

Note 1: "E" is device code, fixed.

Note 2: "W" is date code.

Absolute Maximum Rating				
Parameter	Symbol	Min	Max	Unit
Maximum Peak Pulse Current (8/20μs)	I_{PP}		7.5	A
Maximum Peak Pulse Power (8/20μs)	P_{PK}		210	W
ESD per IEC 61000-4-2 (Air)	V_{ESD}	-30	30	kV
ESD per IEC 61000-4-2 (Contact)				
Operating Temperature	T_{OPT}	-40	+125	°C
Storage Temperature	T_{STG}	-55	+150	°C

Electrical Characteristics $T_A = 25^\circ\text{C}$						
Parameter	Symbol	Test Condition	Min	Typ	Max	Unit
Nominal Reverse Working Voltage	V_{RWM}				12	V
Reverse Leakage Current @ V_{RWM}	I_R	$V_{RWM} = 12\text{V}, T = 25^\circ\text{C}$ Between I/O_1 and I/O_2		0.01	0.1	μA
Reverse Breakdown Voltage @ I_T	V_{BR}	$I_T = 1\text{mA}$ Between I/O_1 and I/O_2	13.3		18	V
Clamping Voltage @ I_{PP}	$V_C(1)$	$I_{PP} = 1\text{A}, t_p = 8/20\mu\text{s}$ Between I/O_1 and I/O_2			20	V
Clamping Voltage @ I_{PP}	$V_C(1)$	$I_{PP} = 7.5\text{A}, t_p = 8/20\mu\text{s}$ Between I/O_1 and I/O_2			28	V
Parasitic Capacitance	$C_{ESD}(1)$	$V_R = 0\text{V}, f = 1\text{MHz}$ Between I/O_1 and I/O_2		25	30	pF

Note 1: Guaranteed by design and not subject to production test.

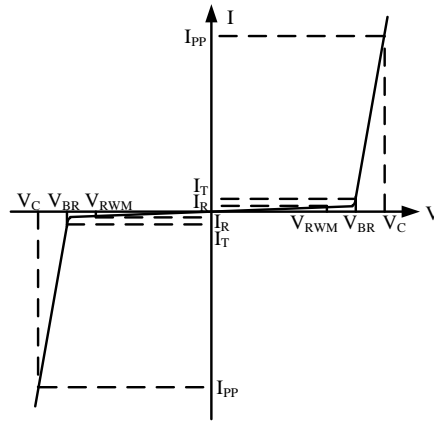
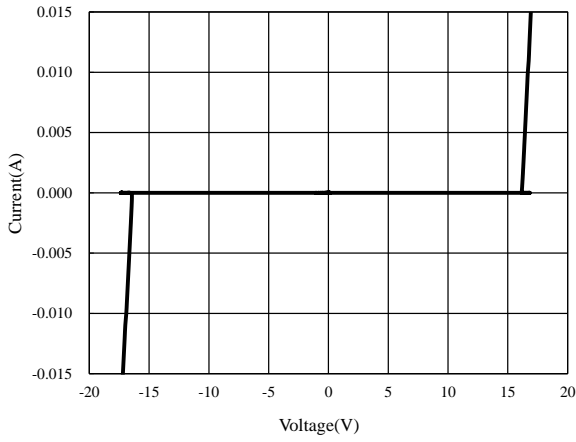

Figure 1. Bi-directional TVS

Typical Characteristics

Voltage Sweeping of I/O_1 to I/O_2



Capacitance vs. Voltage

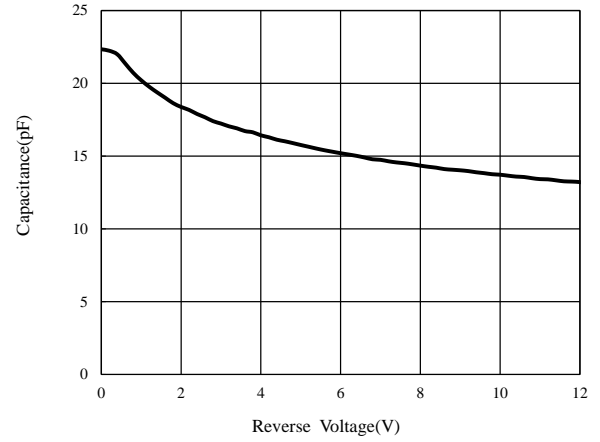

Pulse Waveform

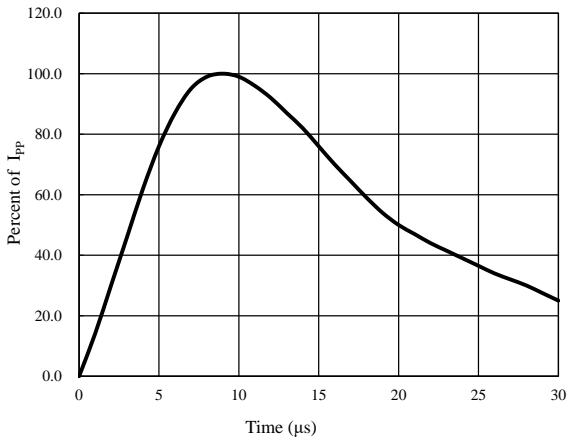

Clamping Voltage vs. Peak Pulse Current

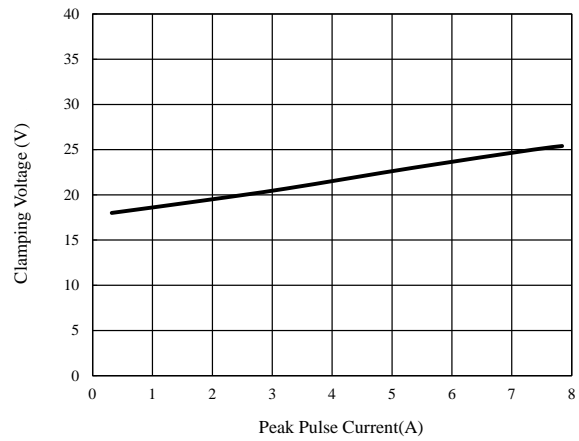

ESD Clamping of I/O_1 to I/O_2 (+8kV Contact per IEC 61000-4-2)

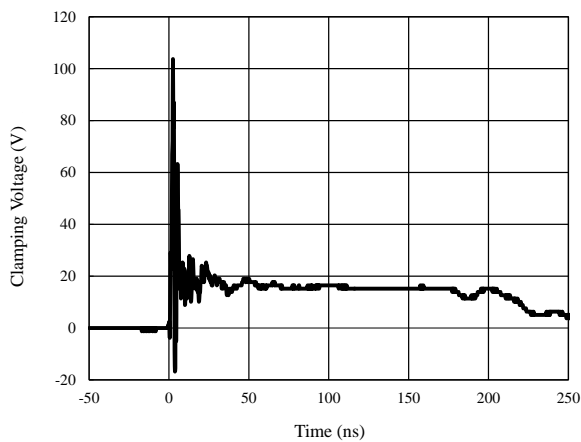

ESD Clamping of I/O_1 to I/O_2 (-8kV Contact per IEC 61000-4-2)

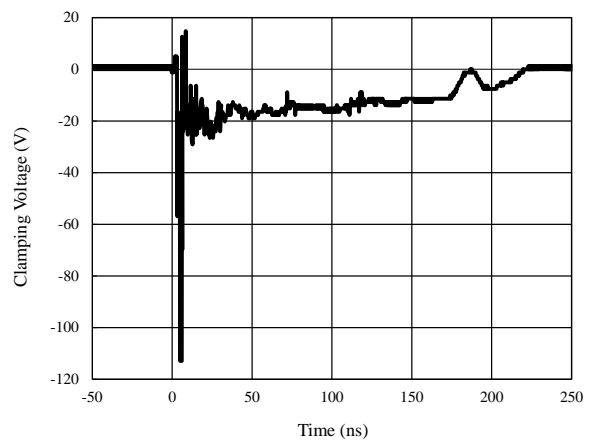

Application Information

The SY205228DWC protects one bidirectional data line against over-voltage and over-current transient events by clamping it to an acceptable reference.

The SY205228DWC pin connections are shown in Figure 2. The protected line is connected at Pin1 while Pin2 is connected to GND, which should connect to a ground plane on the board. All path lengths connected to pins of SY205228DWC should be as short as possible to minimize the parasitic inductance.

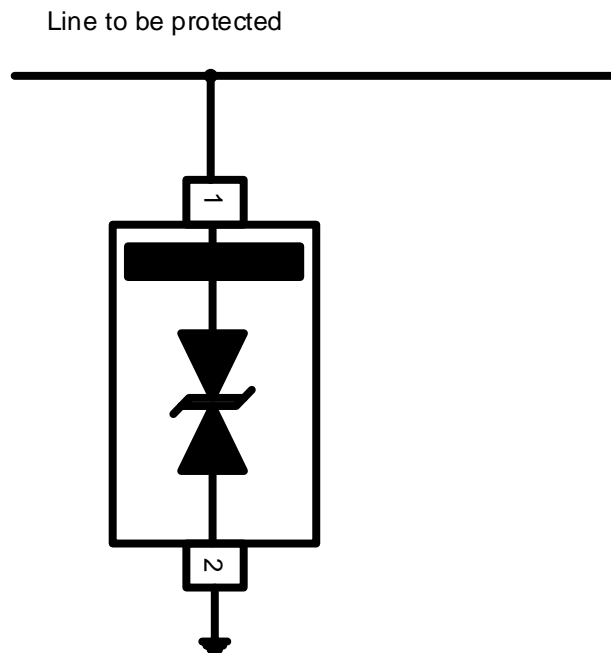

Figure 2. ESD/Surge Protection Circuit

PCB Layout Guidelines

For optimum ESD protection and circuit performance, the following circuit board guidelines are recommended:

- Place SY205228DWC as close to the connector or terminal ports as possible.
- Use a large via to connect the SY205228DWC pin to the ground.
- Avoid running signals near board edges.
- The SY205228DWC should be placed near the protected line.
- The distance between the SY205228DWC ground pin and the GND reference path should be as short as possible.

DFN1.0x0.6-2 Package Outline

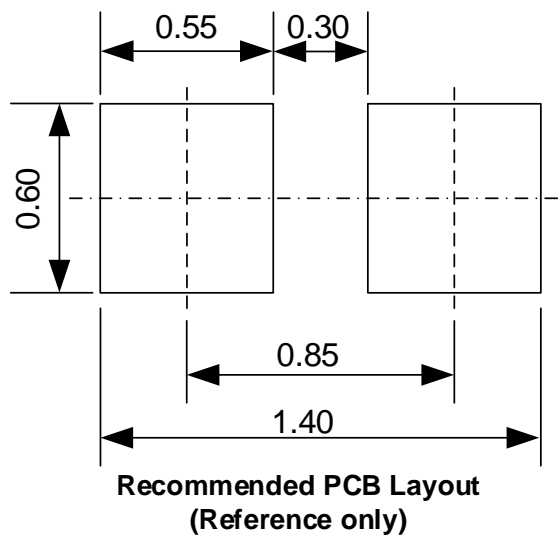
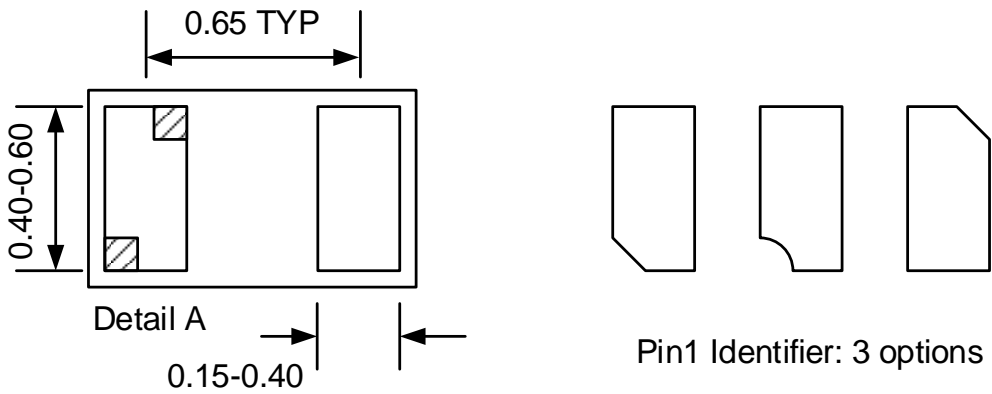
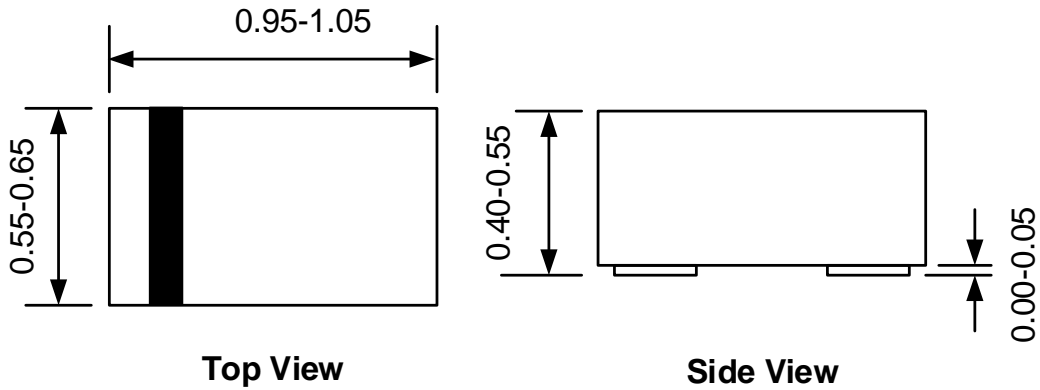

Notes: All dimension in mm and exclude mold flash & metal burr.

Tape and Reel Specification

DFN1.0x0.6-2 Taping Orientation

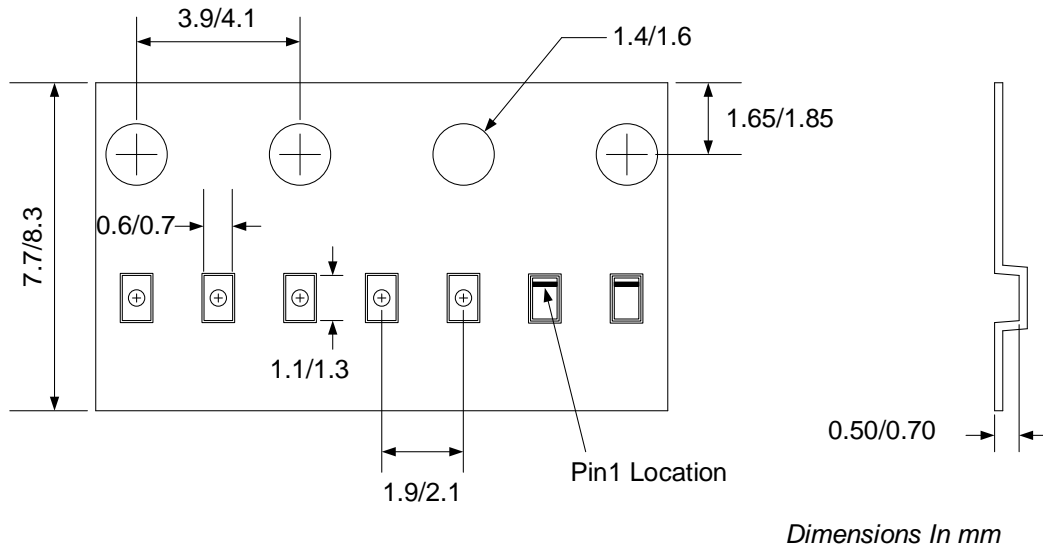

Feeding direction →

Carrier Tape & Reel Specification for Packages

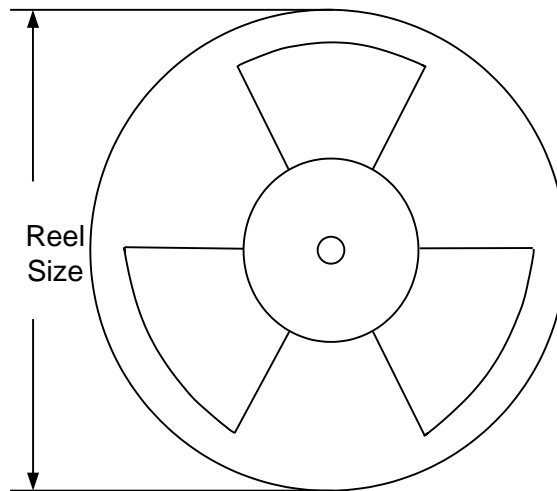

Package Types	Tape Width (mm)	Pocket Pitch(mm)	Reel Size (Inch)	Qty per Reel(pcs)
DFN1.0x0.6-2	8	2	7"	10000



Revision History

The revision history provided is for informational purpose only and is believed to be accurate, however, not warranted. Please make sure that you have the latest revision.

Revision Number	Revision Date	Description	Pages changed
0.9	10/16/2018	Initial Release	
1.0	10/16/2019	Production Release	



IMPORTANT NOTICE

1. **Right to make changes.** Silergy and its subsidiaries (hereafter Silergy) reserve the right to change any information published in this document, including but not limited to circuitry, specification and/or product design, manufacturing or descriptions, at any time and without notice. This document supersedes and replaces all information supplied prior to the publication hereof. Buyers should obtain the latest relevant information before placing orders and should verify that such information is current and complete. All semiconductor products are sold subject to Silergy's standard terms and conditions of sale.

2. **Applications.** Application examples that are described herein for any of these products are for illustrative purposes only. Silergy makes no representation or warranty that such applications will be suitable for the specified use without further testing or modification. Buyers are responsible for the design and operation of their applications and products using Silergy products. Silergy or its subsidiaries assume no liability for any application assistance or designs of customer products. It is customer's sole responsibility to determine whether the Silergy product is suitable and fit for the customer's applications and products planned. To minimize the risks associated with customer's products and applications, customer should provide adequate design and operating safeguards. Customer represents and agrees that it has all the necessary expertise to create and implement safeguards which anticipate dangerous consequences of failures, monitor failures and their consequences, lessen the likelihood of failures that might cause harm and take appropriate remedial actions. Silergy assumes no liability related to any default, damage, costs or problem in the customer's applications or products, or the application or use by customer's third-party buyers. Customer will fully indemnify Silergy, its subsidiaries, and their representatives against any damages arising out of the use of any Silergy components in safety-critical applications. It is also buyers' sole responsibility to warrant and guarantee that any intellectual property rights of a third party are not infringed upon when integrating Silergy products into any application. Silergy assumes no responsibility for any said applications or for any use of any circuitry other than circuitry entirely embodied in a Silergy product.

3. **Limited warranty and liability.** Information furnished by Silergy in this document is believed to be accurate and reliable. However, Silergy makes no representation or warranty, expressed or implied, as to the accuracy or completeness of such information and shall have no liability for the consequences of use of such information. In no event shall Silergy be liable for any indirect, incidental, punitive, special or consequential damages, including but not limited to lost profits, lost savings, business interruption, costs related to the removal or replacement of any products or rework charges, whether or not such damages are based on tort or negligence, warranty, breach of contract or any other legal theory. Notwithstanding any damages that customer might incur for any reason whatsoever, Silergy' aggregate and cumulative liability towards customer for the products described herein shall be limited in accordance with the Standard Terms and Conditions of Sale of Silergy.

4. **Suitability for use.** Customer acknowledges and agrees that it is solely responsible for compliance with all legal, regulatory and safety-related requirements concerning its products, and any use of Silergy components in its applications, notwithstanding any applications-related information or support that may be provided by Silergy. Silergy products are not designed, authorized or warranted to be suitable for use in life support, life-critical or safety-critical systems or equipment, nor in applications where failure or malfunction of a Silergy product can reasonably be expected to result in personal injury, death or severe property or environmental damage. Silergy assumes no liability for inclusion and/or use of Silergy products in such equipment or applications and therefore such inclusion and/or use is at the customer's own risk.

5. **Terms and conditions of commercial sale.** Silergy products are sold subject to the standard terms and conditions of commercial sale, as published at <http://www.silergy.com/stdterms>, unless otherwise agreed in a valid written individual agreement specifically agreed to in writing by an authorized officer of Silergy. In case an individual agreement is concluded only the terms and conditions of the respective agreement shall apply. Silergy hereby expressly objects to and denies the application of any customer's general terms and conditions with regard to the purchase of Silergy products by the customer.

6. **No offer to sell or license.** Nothing in this document may be interpreted or construed as an offer to sell products that is open for acceptance or the grant, conveyance or implication of any license under any copyrights, patents or other industrial or intellectual property rights. Silergy makes no representation or warranty that any license, either express or implied, is granted under any patent right, copyright, mask work right, or other intellectual property right. Information published by Silergy regarding third-party products or services does not constitute a license to use such products or services or a warranty or endorsement thereof. Use of such information may require a license from a third party under the patents or other intellectual property of the third party, or a license from Silergy under the patents or other intellectual property of Silergy.

For more information, please visit: www.silergy.com

© 2023 Silergy Corp.

All Rights Reserved.