

High Efficiency Bi-direction Power Bank Regulator for Single-cell Battery Power Bank

General Description

The SY20718E is a 5V adapter input with up to 18V surge bi-directional regulator which is designed for single cell Li-Ion battery power bank application. Advanced bi-directional energy flow control with automatic input power source detection is adopted to achieve battery charging mode and battery power supply mode alternately.

The SY20718E also integrates the discharging enable/disable control and LED status indication.

The SY20718E is available in QFN3x3 package to minimize the PCB layout size for wide portable applications.

Ordering Information

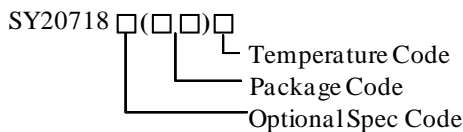

Ordering Number	Package type	Note
SY20718EQDC	QFN3x3-16	

Features

- Maximum 18V Input Voltage Surge
- Bad Adapter Detection
- Build in Power Path NFETs and Power Switches
- 500kHz Switching Frequency Operation
- Trickle Current / Constant Current / Constant Voltage Charge Mode with Internal Compensation
- Maximum 2A Constant Charge Current
- Maximum 2.5A Boost Output Current
- 4.25V/4.4V Selectable Battery Cell Voltage
- +/-0.5% Cell Voltage Accuracy
- Charge/Discharge/Fault Status Indicator
- Discharging Control Logic
- Programmable Input Current Limit
- Dynamic Power Management
- Cycle-by-cycle Peak Current Limitation
- Input Voltage UVLO and OVP
- Boost Output Short Circuit Protection
- Thermal Shutdown

Applications

- Single Cell Power Bank
- Portable Device with Single Cell Battery

Typical Applications

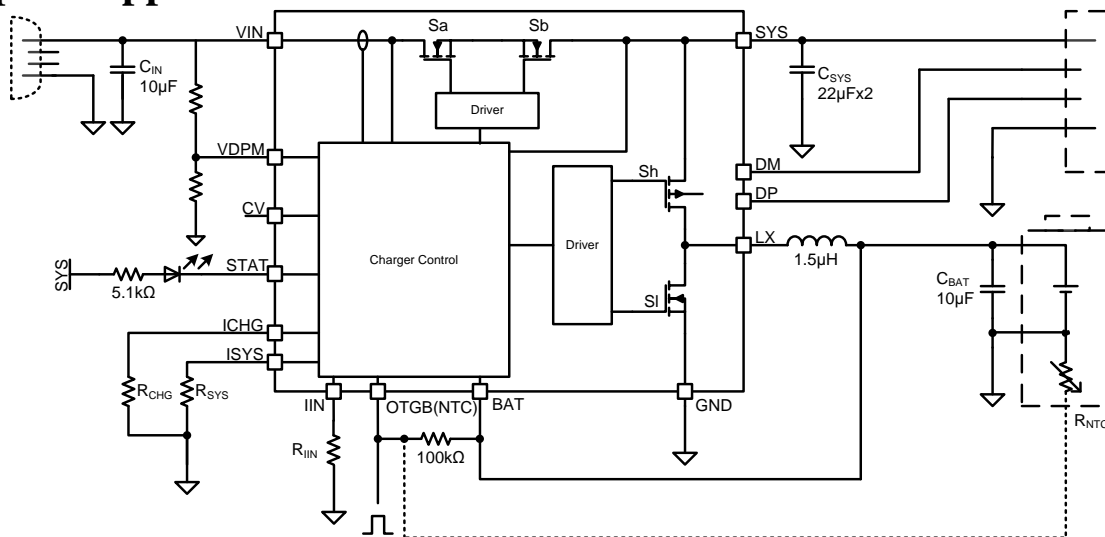
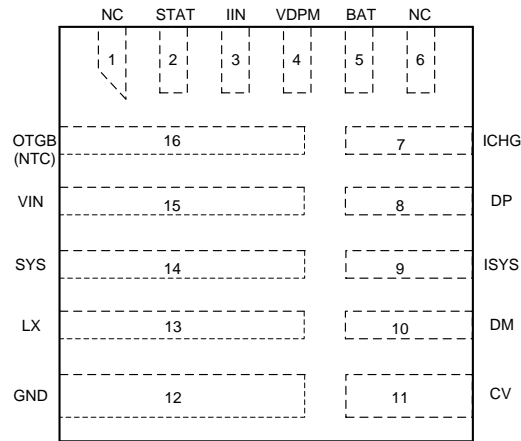

Figure 1. Schematic Diagram

Pinout (top view)



(QFN3x3-16)

Top Mark: **DBU***xyz*, (Device code: DBU, *x*=year code, *y*=week code, *z*=lot number code)

Name	Number	Description
NC	1	Not connected.
STAT	2	Charge or discharge status indication pin. Open drain output. Pull high to SYS through a LED to indicate the charge or discharge in process. When the charge is done, the LED will be off. This LED is also used as a fault indicator.
IIN	3	Connect a resistor to set the input current limit in Buck mode.
VDPM	4	Voltage sense for input dynamic management. If the voltage drops to the internal 1.225V reference voltage, the VIN will be clamped to the setting value.
BAT	5	Battery voltage sense pin. It is used as battery constant voltage control and battery voltage protections.
NC	6	Not connected.
ICHG	7	Connect a resistor to set charge current limit in Buck mode.
DP	8	D+/D- output for USB port connection. It supports BC1.2 handshaking, and also supports Apple and Samsung portable device.
DM	10	
ISYS	9	Connect a resistor to set SYS current limit in Boost mode.
CV	11	Charge voltage selection pin. Open or pull it low for 4.25V. Pull it high for 4.4V.
GND	12	Power ground.
LX	13	Switch node pin. Connect it to the external inductor.
SYS	14	System connection point. Add at least 2pcs of 22μF MLCC here.
VIN	15	Power input pin. Connect a MLCC from this pin to ground to decouple high harmonic noise. This pin has OVP and UVLO function to make the charger operate within safe input voltage range.
OTGB(NTC)	16	Discharging enable/disable control or charging thermal sense pin. In discharging mode, OTGB pin LOW enables Boost, HIGH disables Boost. In charging mode, pull up to BAT with a resistor. Connect to the NTC pull-down resistor to achieve battery thermal protection. Disable thermal protection without pull-down resistor.



Absolute Maximum Ratings

VIN	-0.3~18V
LX, SYS, STAT, IIN, VDPM, CV, ICHG, ISYS, DP, DM, BAT, OTGB(NTC)	-0.3~6V
VIN Pin Continuous Current	2.5A
SYS Pin Continuous Current	3.5A
LX Pin Continuous Current	8A
Power Dissipation, P _D @ T _A = 25°C, QFN3x3	2.1W
Package Thermal Resistance	
θ _{JA}	48°C/W
θ _{JC}	4°C/W
Junction Temperature Range	-40°C to +125°C
Lead Temperature (Soldering, 10 sec.)	260°C
Storage Temperature Range	-65°C to 125°C

Recommended Operating Conditions

VIN	0~5.5V
LX, SYS, STAT, IIN, VDPM, CV, ICHG, ISYS, DP, DM, BAT, OTGB(NTC)	0~5.5V
VIN Pin Continuous Current	2.0A
SYS Pin Continuous Current	2.5A
LX Pin Continuous Current	6A
Junction Temperature Range	-20°C to 100°C
Ambient Temperature Range	-40°C to 85°C



Electrical Characteristics

T_J=25°C, V_{IN}=5V, C_{IN}=10μF, C_{BAT}=10μF, C_{SYS}=44μF, L=1.5μH, unless otherwise specified.

Symbol	Parameter	Conditions	Min	Typ	Max	Unit
Bias Supply (V_{IN})						
V _{IN}	Input Voltage Operation Range		4.7		5.5	V
V _{INOK}	Adapter OK Voltage	Rising edge	4.35	4.5	4.65	V
ΔV _{INOK}	Adapter OK Voltage Hysteresis	Falling edge		200		mV
V _{OVP}	Input Overvoltage Protection	Rising edge	5.7	5.85	6.0	V
ΔV _{OVP}	Input Overvoltage Protection Hysteresis	Falling edge		200		mV
V _{DPM}	Input Voltage REF for Adaptive Input Current Limit		1.2	1.225	1.25	V
Quiescent Current						
I _{BAT}	Battery Discharge Current	Boost shutdown, V _{OTGB} =V _{BAT}			20	μA
I _{IN}	Input Quiescent Current	Disable Charge			1.5	mA
Oscillator and PWM						
f _{OSC}	Switching Frequency			500		kHz
Power MOSFET						
R _{HIGH}	R _{DS(ON)} of High Side P-FET	R _{SH}		35		mΩ
R _{LOW}	R _{DS(ON)} of Low Side N-FET	R _{SL}		20		mΩ
R _{PM}	R _{DS(ON)} of Power Path Management N-FET	R _{SA} +R _{SB}		80		mΩ
I _{CHG_MAX}	Peak Current of Switching FETs in Charge Mode			4.5		A
I _{DIS_MAX}	Peak Current of Switching FETs in Discharge Mode			8		A
Voltage Threshold and Regulation						
V _{CV}	Cell Voltage Tolerance	V _{CV} = 4.4V	4.378	4.4	4.422	V
ΔV _{RCH}	CV Hysteresis for Recharge	V _{CV} = 4.4V	45	100	170	mV
V _{SYS}	Discharge Output Voltage at SYS	V _{BAT} =3.7V	5.1	5.2	5.3	V
Current Regulation						
I _{CC}	Internal Charge Current Accuracy for Constant Current Mode	R _{CHG} =2.55kΩ (I _{CC} =2A)	-10		10	%
I _{TC}	Internal Charge Current for Trickle Current Mode	R _{CHG} =2.55kΩ (I _{CC} =2A)		0.1		I _{CC}
I _{TERM}	Termination Current	R _{CHG} =2.55kΩ (I _{CC} =2A)		0.1		I _{CC}
I _{INDPM}	Maximum Input Current Limit When Charger is Switching.	R _{IIN} =0.75kΩ, I _{CHG} =1A	2.25	2.5	2.75	A
System and BAT OVP						
V _{SYS_OVP}	SYS Voltage OVP Threshold	Rising edge	103%	105%	107%	V _{SYS}
ΔV _{SYS_OVP}	SYS Voltage OVP Hysteresis	Falling edge		2%		V _{SYS}
V _{BAT_OVP}	BAT Voltage OVP Threshold	Rising edge	103%	105%	107%	V _{CV}
ΔV _{BAT_OVP}	BAT Voltage OVP Hysteresis	Falling edge		2%		V _{CV}
Battery Weak						
V _{DPL}	Battery Depletion Threshold	Falling edge		2.5		V
ΔV _{DPL}	Battery Depletion Hysteresis	Rising edge		300		mV
V _{TRK}	Battery Trickle Charge Threshold	Falling edge	2.5	2.6	2.7	V
ΔV _{TRK}	Battery Trickle Charge Hysteresis	Rising edge		200		mV
BAT Short Protection						
V _{SHORT}	Output Short Protection Threshold	V _{BAT} falling edge	1.9	2.0	2.1	V



SY20718E

SYS Over Current Protection						
I _{SYSMAX}	SYS Current Limit on Boost Mode	V _{BAT} =3.7V, R _{SYS} =2.2kΩ	2.25	2.5	2.75	A
Timing						
t _{TC}	Trickle Current Charge Timeout			2		hour
t _{OC}	ACOC Deglitch Time			600		μs
Battery Thermal Protection						
V _{UTP}	UTP Threshold	Rising edge	65.7%	67.7%	69.7%	V _{BAT}
	UTP Hysteresis	Falling edge		3.5%		V _{BAT}
V _{OTP}	OTP Threshold	Falling edge	29.9%	31.9%	33.9%	V _{BAT}
	OTP Hysteresis	Rising edge		2%		V _{BAT}
V _{NTCHIGH}	High Voltage to Disable NTC Function	Rising edge		90%		V _{BAT}
V _{OTGB}	OTGB Active Low Voltage	Falling edge		0.35		V
Thermal Regulation and Thermal Shutdown						
T _{TSD}	Thermal Shutdown Threshold			150		°C
ΔT _{TSD}	Thermal Shutdown Hysteresis			30		°C

Note 1: Stresses beyond the “Absolute Maximum Ratings” may cause permanent damage to the device. These are stress ratings only. Functional operation of the device at these or any other conditions beyond those indicated in the operational sections of the specification is not implied. Exposure to absolute maximum rating conditions for extended periods may affect device reliability.

Note 2: θ_{JA} is measured in the natural convection at T_A = 25°C on a low effective four-layer thermal conductivity test board of JEDEC 51-3 thermal measurement standard.

Note 3: The device is not guaranteed to function outside its operating conditions.

General Function Description

The SY20718E is a 5V adapter input with up to 18V surge bi-directional regulator which is designed for single cell Li-Ion battery power bank application. Advanced bi-directional energy flow control with automatic input power source detection is adopted to achieve battery charging mode and battery power supply mode alternately. If the external power supply is present, SY20718E will run in battery charging mode with fully protection function. If the external power supply is absent, SY20718E will run in battery power supply mode with output current capability up to 2.5A.

The SY20718E integrates blocking switches to prevent current leaking from the system side or the battery side to the input side. The high side switch protects the battery from high discharge current and short circuits at SYS point.

The SY20718E also provides the OTGB control and LED status indication.

OTGB and NTC Function

OTGB can control the Boost, pull OTGB low to enable the Boost and high to disable the Boost.

The OTGB pin will also be used as the battery NTC temperature sensing in charging mode if the voltage is lower than 90% of V_{BAT} . When OTGB voltage is higher than V_{UTP} or lower than V_{OTP} , the IC will shut down the charger and indicate the fault.

LED Status Indication Description

Connecting a LED to STAT pin can indicate the charging status, the discharging status and the fault mode.

1. Charging Mode - When the adapter is present, SY20718E will work in charging mode even the charging is done. In charging mode, the LED ON indicates the charging ongoing and the LED OFF indicates the charging done.
2. Discharging Mode - When the adapter is removed, and the Boost is enabled, the IC will work in discharging mode. In discharging mode, the LED ON indicates the discharging ongoing.
3. Fault Mode – When any fault (input OVP, battery OVP, SYS OVP, battery short, NTC faults, thermal shutdown, timeout, SYS short) occurs, the LED will flash at 2Hz.

The detailed LED status description is as follows:

- Charging mode: STAT low
- Charging done: STAT high
- Discharging mode: STAT low
- Fault mode: 2Hz flash

Input Dynamic Power Management

SY20718E can manage the input power limit very well. It has input VDPM and IDPM function to protect the input source from high current.

The IC can set the input source power capability in charging mode. The minimum input voltage limit can be set by connecting a resistor divider from VIN to VDPM pin. The maximum input current limit is determined by the resistor from IIN pin to GND.

The relationship between the input current limit and R_{IIN} is showed in the below curve.

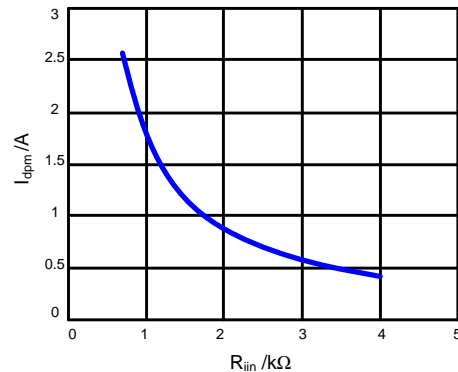

Test condition: $V_{IN}=5V$, $V_{BAT}=3.7V$

Charge Current Setting

In charging mode, SY20718E mirrors the current information to the ICHG pin and the charge current is determined by the resistance from the ICHG pin to GND.

The relationship between the charging current and R_{CHG} is showed in the below curve.

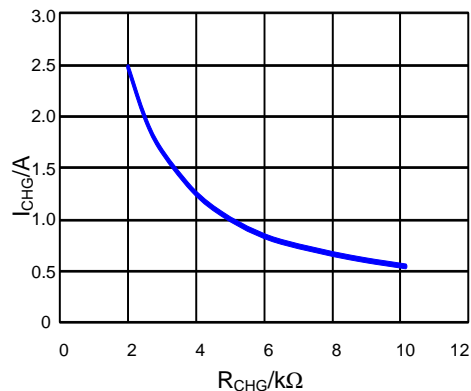

Test condition: $V_{IN}=5V$, $V_{BAT}=3.7V$

The SY20718E has a good I_{CHG} regulation performance even in wide V_{IN} and V_{BAT} range. The relationship between the charging current and V_{BAT} is showed in below curves.

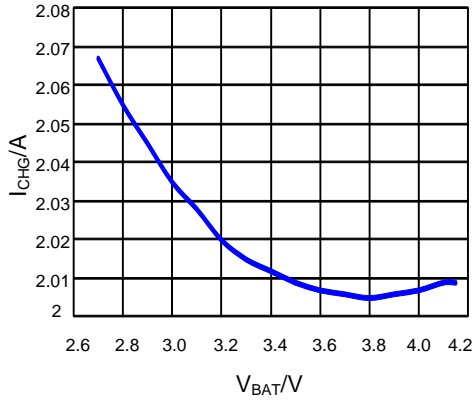

Test condition: $V_{IN}=5V$, $R_{CHG}=2.5k\Omega$

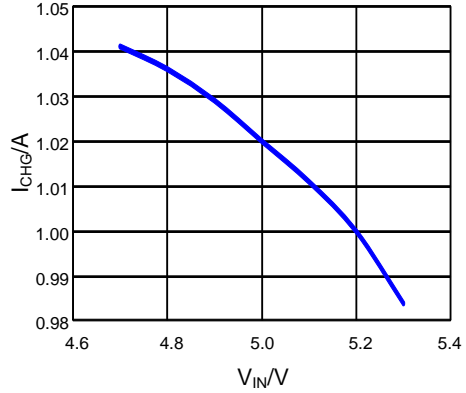

Test condition: $V_{BAT}=3.7V$, $R_{CHG}=5k\Omega$

SYS Current Limit Setting

In discharge mode, SY20718E mirrors the current information to the ISYS pin and the discharge current limit is determined by the resistor from the ISYS pin to GND.

The relationship between the discharge current limit and R_{SYS} is showed in the below curve.

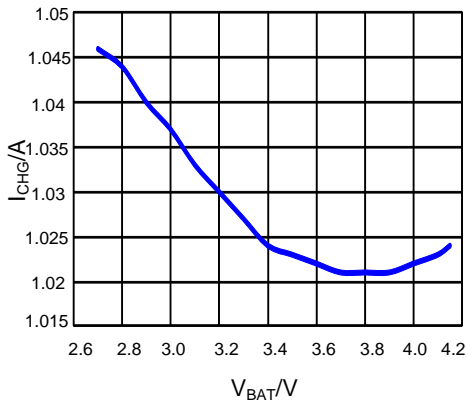

Test condition: $V_{IN}=5V$, $R_{CHG}=5k\Omega$

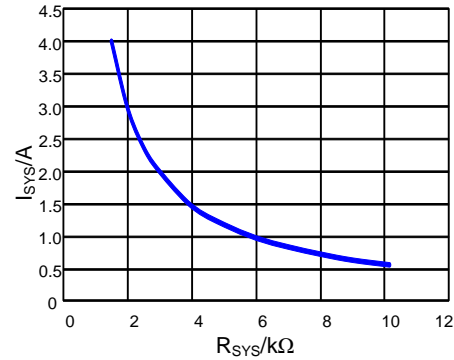

Test condition: $V_{BAT}=3.7V$, $V_{SYS}=4.7V$

The relationship between the charging current and V_{IN} is showed in the below curve.

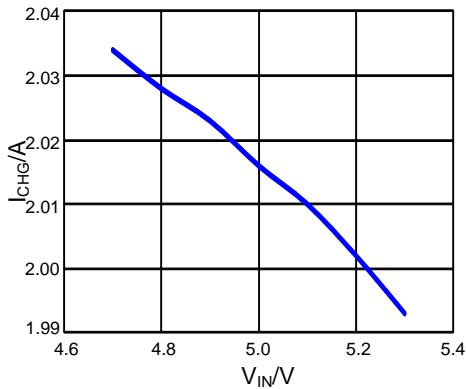

Test condition: $V_{BAT}=3.7V$, $R_{CHG}=2.5k\Omega$

The SY20718E has a good I_{SYS} regulation performance even in wide V_{SYS} and V_{BAT} range. The relationship between the discharge current limit and V_{SYS} is showed in below curves.

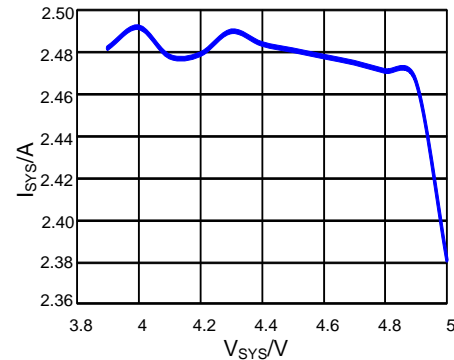

Test condition: $V_{BAT}=3.7V$, $R_{SYS}=2.2k\Omega$

The relationship between the discharge current limit and V_{BAT} is showed in the below curve.

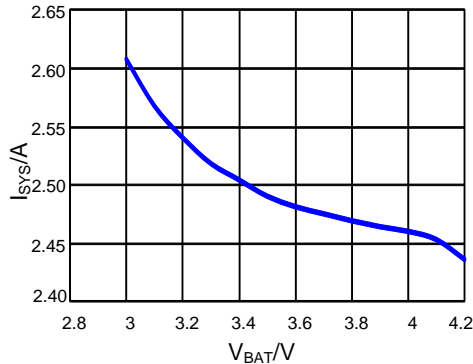

Test condition: $V_{SYS}=4.7V$, $R_{SYS}=2.2k\Omega$

Buck Charger Basic Operation Description

The SY20718E will work as a synchronous Buck mode battery charger when the adapter is present. It utilizes 500 kHz switching frequency to minimize the PCB design.

The charger will operate in battery short mode, trickle charge mode, constant current charge mode and constant voltage charge mode according to the battery voltage. The charge current in every mode is showed in the below charge curve.

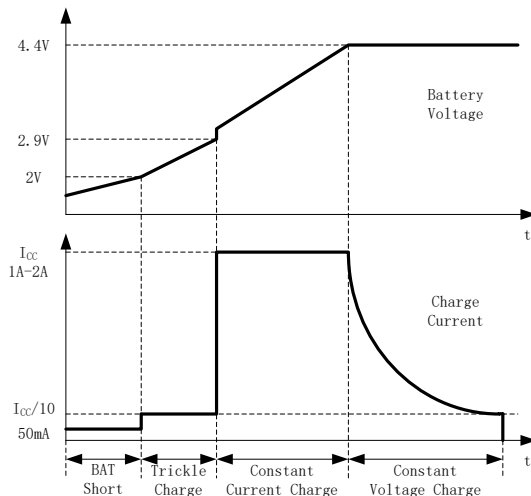

In charging mode, SY20718E has full protection to protect the IC and the battery.

Input Over Voltage Protection – SY20718E has both VIN and SYS over voltage protection. It will turn off blocking FETs and switching charger when input OVP occurs. The IC will automatically return to normal operation when fault is removed.

BAT Over Voltage Protection – SY20718E will stop charging when BAT OVP occurs. The IC will automatically return to normal operation when fault is removed.

Timeout Protection – The charger can detect a bad battery. It will stop charge and latch off when the charger works over 2 hours in trickle mode. Only recycling the input can release this fault.

Input Over Current Protection – SY20718E has hiccup mode input over current protection. The threshold is 25% higher than the IDMP value.

Battery Thermal Protection – Battery thermal protection is only available in charging mode. When OTGB voltage is lower than OTP threshold or higher than UTP threshold and lower than 90% of BAT, the charger will stop switching. The IC will automatically return to normal operation when fault is removed.

Boost Mode Basic Operation Description

The battery can supply the portable device connected to SYS pin when the adapter is removed. The converter works as a 500kHz synchronous Boost which can deliver up to 2.5A current to the load.

The Boost provides 5.2V for the portable device. It limits the output current which is set by R_{SYS}.

In Boost mode, SY20718E provides full protection for the portable device, the battery and itself.

SYS Over Voltage Protection – SY20718E will stop switching when SYS OVP occurs. The IC will automatically return to normal operation when fault is removed.

BAT Depletion Protection – SY20718E will stop operation when BAT depletion occurs. To recover switching, the IC needs to be enabled again after fault is removed.

Common Protection Description

SY20718E also provides some common protections to prevent all the related devices.

SYS Short Protection – SY20718E will stop switching and enter hiccup mode when SYS short occurs.

Thermal Shutdown Protection – The IC will stop operation when the junction temperature is higher than 150°C. The IC will automatically return to normal operation when fault is removed.

Typical Performance Characteristics

$T_A=25^{\circ}\text{C}$, $V_{IN}=5\text{V}$, $R_{CHG}=2.55\text{k}\Omega$, $R_{SYS}=2.2\text{k}\Omega$, single cell battery, unless otherwise specified.

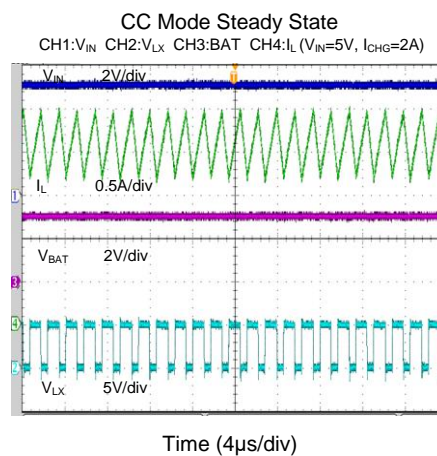
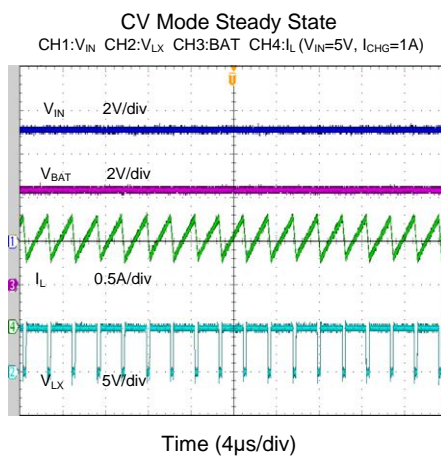
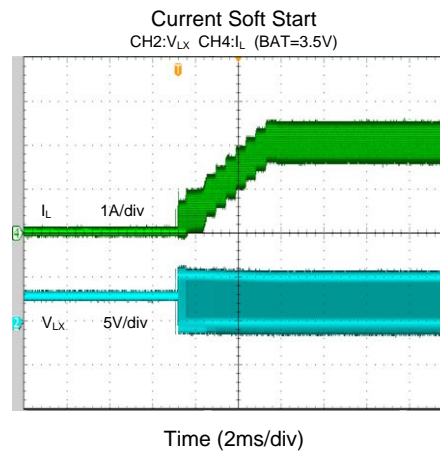
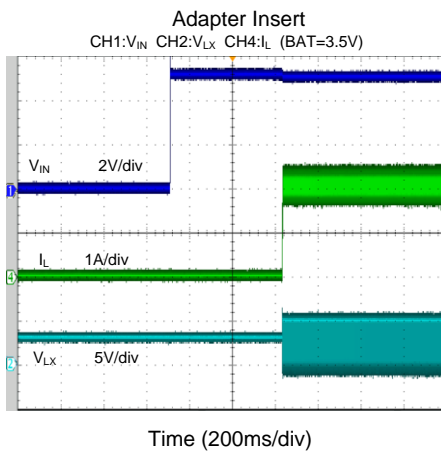
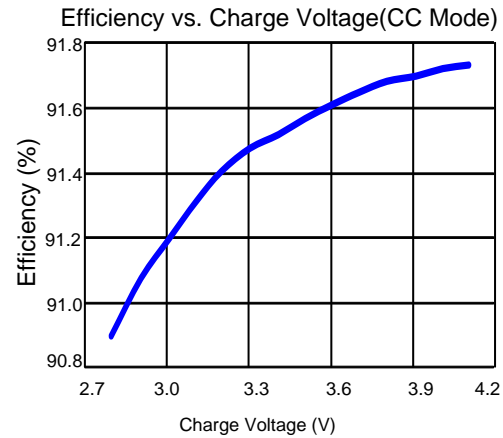
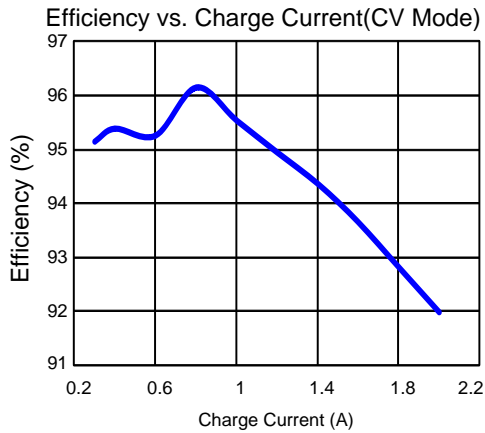

Efficiency vs. SYS Current

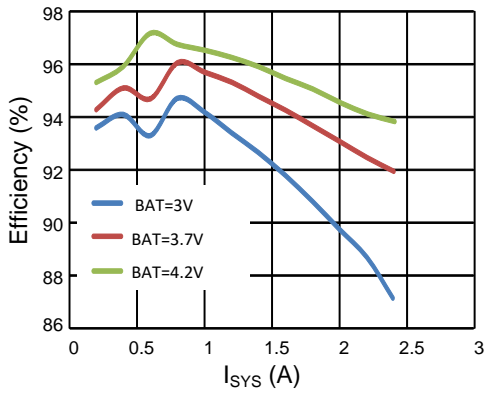

OTGB Enable and Disable Discharge

CH1:V_{OTGB} CH2:V_{LX} CH3:V_{BAT} CH4:I_L

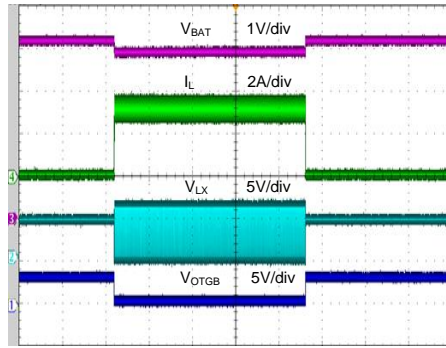

Time (400ms/div)

Boost Mode Steady State

CH2:V_{LX} CH3: ΔV_{SYS} CH4:I_L(I_{SYS}=0.05A)

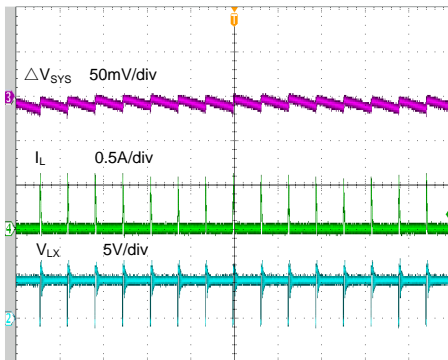

Time (40μs/div)

Boost Mode Steady State

CH2:V_{LX} CH3: ΔV_{SYS} CH4:I_L(I_{SYS}=2A)

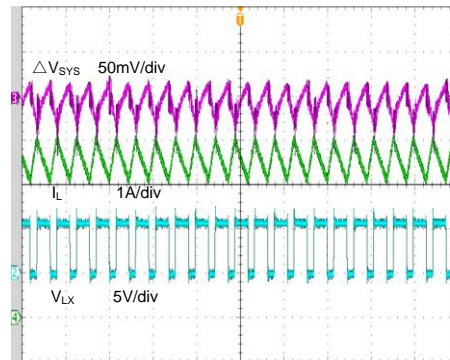

Time (4μs/div)

Applications Information

The SY20718E is a very high integrated IC for power bank application. The application circuits based on this regulator is rather simple. Only filter capacitors (C_{IN} , C_{BAT} and C_{SYS}), inductor L, NTC resistors R_1 , R_2 and current setting resistors (R_{CHG} , R_{SYS}) need to be selected for the target applications specifications.

NTC Resistor

The SY20718E monitors battery temperature by measuring the input voltage and NTC voltage. The controller will trigger the UTP or OTP when the rate K ($K = V_{NTC}/V_{BAT}$) reaches the threshold of UTP (K_{UT}) or OTP (K_{OT}). The temperature sensing network is showed as below.

Choose R_1 and R_2 to program the proper UTP and OTP points.

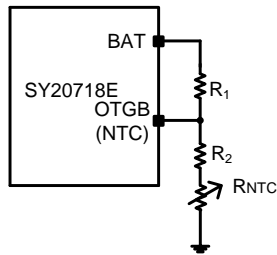

The calculation steps are:

1. Define K_{UT} , $K_{UT} = 65.7\% \sim 69.7\%$
2. Define K_{OT} , $K_{OT} = 29.9\% \sim 33.9\%$
3. Assume the resistance of the battery NTC thermistor is R_{UT} at UTP threshold and R_{OT} at OTP threshold.
4. Calculate R_2 ,

$$R_2 = \frac{K_{OT}(1 - K_{UT})R_{UT} - K_{UT}(1 - K_{OT})R_{OT}}{K_{UT} - K_{OT}}$$

5. Calculate R_1

$$R_1 = (1/K_{OT} - 1)(R_2 + R_{OT})$$

If choose the typical values $K_{UT} = 67.7\%$ and $K_{OT} = 31.9\%$, then

$$R_2 = 0.288R_{UT} - 1.288R_{OT}$$

$$R_1 = 2.135(R_2 + R_{OT})$$

The SY20718E accepts various NTC divider circuits. For below method, R_1 and R_2 can be calculated by below equations.

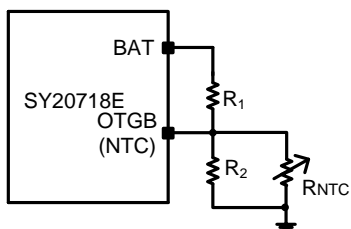

$$R_2 = \frac{R_{OT}R_{UT}(K_{UT} - K_{OT})}{K_{OT}K_{UT}(R_{UT} - R_{OT}) + R_{UT}K_{OT} - R_{OT}K_{UT}}$$

$$R_1 = \frac{R_2R_{UT}(1 - K_{UT})}{K_{UT}(R_2 + R_{UT})}$$

If we choose the typical values $K_{UT} = 67.7\%$ and $K_{OT} = 31.9\%$, then

$$R_2 = \frac{0.358R_{UT}R_{OT}}{0.103R_{UT} - 0.461R_{OT}}$$

$$R_1 = \frac{0.477R_2R_{UT}}{R_{UT} + R_2}$$

Input Capacitor C_{IN}

X5R or X7R ceramic capacitors with greater than $10\mu F$ capacitance are recommended to handle this ripple current. The voltage rating of the output capacitor should be higher than 16V.

Output Capacitor C_{BAT}

The charger output capacitor is selected to handle the output ripple noise requirements. This ripple voltage is related to the capacitance and its equivalent series resistance (ESR). For the best performance, it is recommended to use an X5R or better grade low ESR ceramic capacitor. The voltage rating of the output capacitor should be higher than 10V.

To design a smaller output ripple, greater than $10\mu F$ capacitance is recommended.

Output Capacitor C_{SYS}

The Boost output capacitor is selected to handle the output ripple noise and out load transient requirements. For the best performance, it is recommended to use an X5R or a better grade low ESR ceramic capacitor. The voltage rating of the output capacitor should be higher than 10V.

To design a smaller output ripple and a better transient performance, greater than 2pcs of $22\mu F$ capacitance is recommended.

Inductor L

There are several considerations in choosing this inductor.

- 1) Choose the inductance to provide the desired ripple current. It is suggested to choose the ripple current to be about 40% of the average input current. The Boost inductor current is worse than the charger mode, so we choose the inductor based on Boost mode. The inductance is calculated as:

$$L = \left(\frac{V_{BAT}}{V_{SYS}} \right)^2 \frac{V_{SYS} - V_{BAT}}{I_{SYS} \cdot F_{SW} \cdot 40\%}$$

Where F_{sw} is the switching frequency and I_{SYS} is the setting discharge current.

The SY20718E is quite tolerant of different ripple current amplitudes. Consequently, the final choice of inductance can be slightly off the calculation value without significantly impacting the performance.

Recommend the $1.5\mu H$ inductance in SY20718E applications.

- 2) The saturation current rating of the inductor must be selected to be greater than the peak inductor current under full load conditions.

$$I_{SAT} > \frac{V_{SYS} \cdot I_{SYS}}{V_{BAT}} + \left(\frac{V_{BAT}}{V_{SYS}} \right) \times \frac{V_{SYS} - V_{BAT}}{2 \cdot F_{sw} \cdot L}$$

- 3) The DCR of the inductor and the core loss at the switching frequency must be low enough to achieve the desired efficiency requirement. It is desirable to choose an inductor with $DCR < 10m\Omega$ to achieve a good overall efficiency.

Layout Design

The layout design of SY20718E regulator is relatively simple. For the best efficiency and to minimize noise problems, we should place the following components close to the IC: C_{IN} , L, C_{SYS} , especially C_{SYS} .

- 1) The loop of main MOSFET, rectifier MOSFET, and C_{SYS} must be as short as possible.

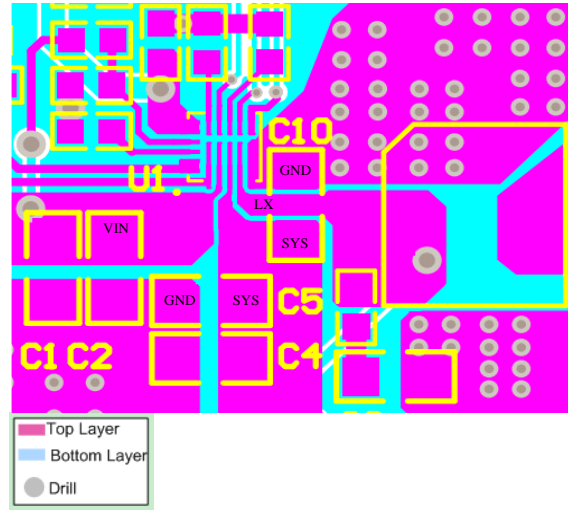

- 2) It is desirable to maximize the PCB copper area connected to GND pin to achieve the best thermal and noise performance.
- 3) C_{IN} must be close to pin VIN and GND.
- 4) The PCB copper area connected to LX pin must be minimized to avoid the potential noise problem.
- 5) The small signal component RCHG, RSYS must be placed close to the IC and must not be adjacent to the LX net on the PCB layout to avoid the noise problem.

QFN3x3-16 Package Outline Drawing

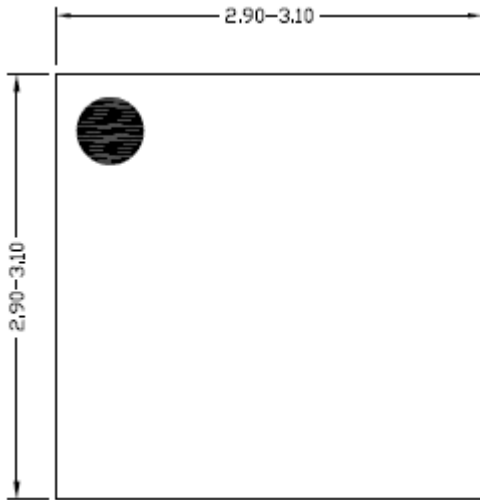

Top View

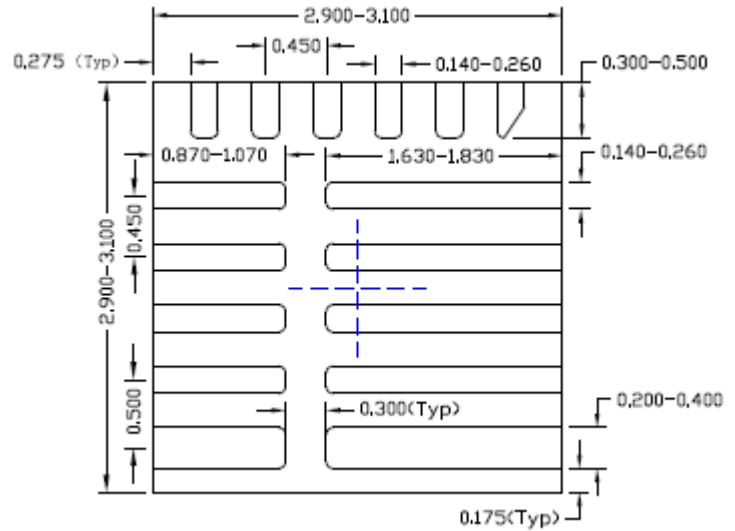

Bottom View

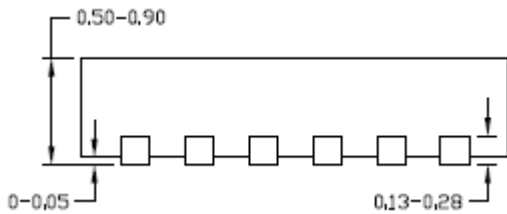

Side View

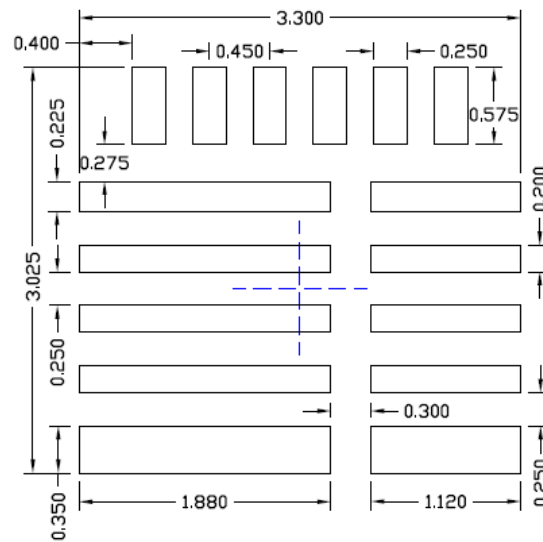

**Recommended PCB layout
(Reference Only)**

Notes: All dimension in millimeter and exclude mold flash & metal burr.

Taping & Reel Specification

1. Taping orientation

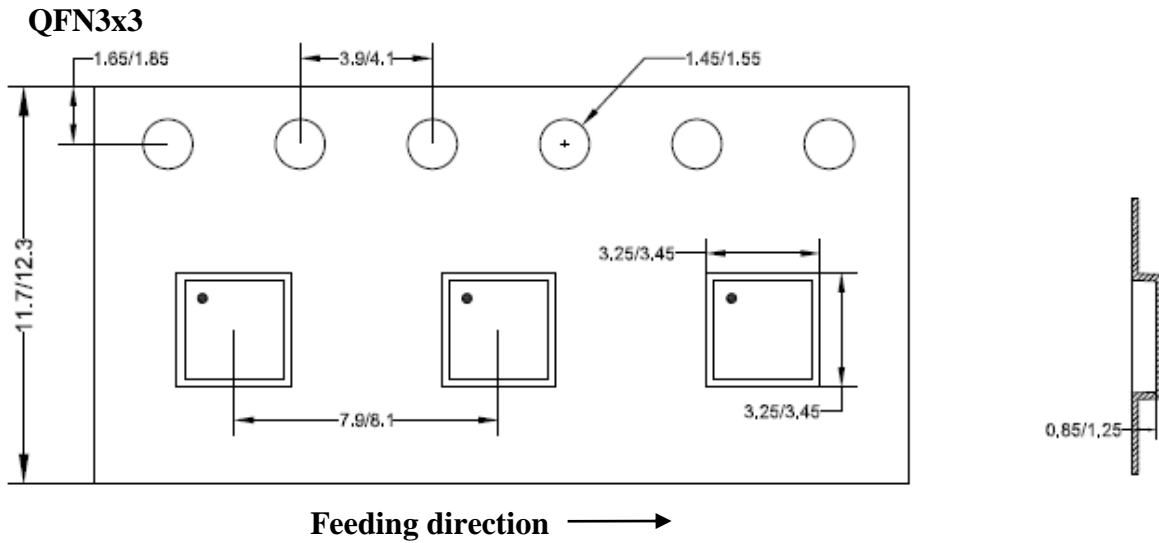

2. Carrier Tape & Reel specification for packages

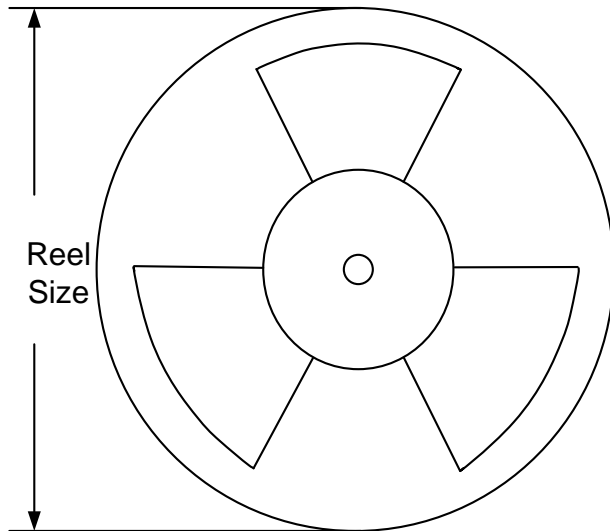

Package types	Tape width (mm)	Pocket pitch(mm)	Reel size (Inch)	Trailer length(mm)	Leader length (mm)	Qty per reel
QFN3x3	12	8	13"	400	400	5000

3. Others: NA



IMPORTANT NOTICE

- 1. Right to make changes.** Silergy and its subsidiaries (hereafter Silergy) reserve the right to change any information published in this document, including but not limited to circuitry, specification and/or product design, manufacturing or descriptions, at any time and without notice. This document supersedes and replaces all information supplied prior to the publication hereof. Buyers should obtain the latest relevant information before placing orders and should verify that such information is current and complete. All semiconductor products are sold subject to Silergy's standard terms and conditions of sale.
- 2. Applications.** Application examples that are described herein for any of these products are for illustrative purposes only. Silergy makes no representation or warranty that such applications will be suitable for the specified use without further testing or modification. Buyers are responsible for the design and operation of their applications and products using Silergy products. Silergy or its subsidiaries assume no liability for any application assistance or designs of customer products. It is customer's sole responsibility to determine whether the Silergy product is suitable and fit for the customer's applications and products planned. To minimize the risks associated with customer's products and applications, customer should provide adequate design and operating safeguards. Customer represents and agrees that it has all the necessary expertise to create and implement safeguards which anticipate dangerous consequences of failures, monitor failures and their consequences, lessen the likelihood of failures that might cause harm and take appropriate remedial actions. Silergy assumes no liability related to any default, damage, costs or problem in the customer's applications or products, or the application or use by customer's third-party buyers. Customer will fully indemnify Silergy, its subsidiaries, and their representatives against any damages arising out of the use of any Silergy components in safety-critical applications. It is also buyers' sole responsibility to warrant and guarantee that any intellectual property rights of a third party are not infringed upon when integrating Silergy products into any application. Silergy assumes no responsibility for any said applications or for any use of any circuitry other than circuitry entirely embodied in a Silergy product.
- 3. Limited warranty and liability.** Information furnished by Silergy in this document is believed to be accurate and reliable. However, Silergy makes no representation or warranty, expressed or implied, as to the accuracy or completeness of such information and shall have no liability for the consequences of use of such information. In no event shall Silergy be liable for any indirect, incidental, punitive, special or consequential damages, including but not limited to lost profits, lost savings, business interruption, costs related to the removal or replacement of any products or rework charges, whether or not such damages are based on tort or negligence, warranty, breach of contract or any other legal theory. Notwithstanding any damages that customer might incur for any reason whatsoever, Silergy' aggregate and cumulative liability towards customer for the products described herein shall be limited in accordance with the Standard Terms and Conditions of Sale of Silergy.
- 4. Suitability for use.** Customer acknowledges and agrees that it is solely responsible for compliance with all legal, regulatory and safety-related requirements concerning its products, and any use of Silergy components in its applications, notwithstanding any applications-related information or support that may be provided by Silergy. Silergy products are not designed, authorized or warranted to be suitable for use in life support, life-critical or safety-critical systems or equipment, nor in applications where failure or malfunction of an Silergy product can reasonably be expected to result in personal injury, death or severe property or environmental damage. Silergy assumes no liability for inclusion and/or use of Silergy products in such equipment or applications and therefore such inclusion and/or use is at the customer's own risk.
- 5. Terms and conditions of commercial sale.** Silergy products are sold subject to the standard terms and conditions of commercial sale, as published at <http://www.silergy.com/stdterms>, unless otherwise agreed in a valid written individual agreement specifically agreed to in writing by an authorized officer of Silergy. In case an individual agreement is concluded only the terms and conditions of the respective agreement shall apply. Silergy hereby expressly objects to and denies the application of any customer's general terms and conditions with regard to the purchase of Silergy products by the customer.
- 6. No offer to sell or license.** Nothing in this document may be interpreted or construed as an offer to sell products that is open for acceptance or the grant, conveyance or implication of any license under any copyrights, patents or other industrial or intellectual property rights. Silergy makes no representation or warranty that any license, either express or implied, is granted under any patent right, copyright, mask work right, or other intellectual property right. Information published by Silergy regarding third-party products or services does not constitute a license to use such products or services or a warranty or endorsement thereof. Use of such information may require a license from a third party under the patents or other intellectual property of the third party, or a license from Silergy under the patents or other intellectual property of Silergy.

For more information, please visit: www.silergy.com

© 2018 Silergy Corp.

All Rights Reserved.