

High Efficiency, 2.4MHz, 3A Synchronous Step Down Regulator

General Description

The SY26003 is a high efficiency 2.4MHz synchronous step down DC/DC regulator which is capable of delivering up to 3A output currents. It can operate over a wide input voltage range from 2.5V to 6V and integrates main switch and synchronous switch with very low $R_{DS(ON)}$ to minimize the conduction loss.

Ordering Information

SY26003 □(□□□)

Package Code
Optional Spec Code

Ordering Number	Package type	Note
SY26003SYD	DFN2×2-7	--

Features

- 2.5~6.0V Input Voltage Range
- 23μA Low Quiescent Current
- Low $R_{DS(ON)}$ for Internal Switches (Top/Bottom) 31mΩ /23mΩ
- Instant PWM Control Achieve Ultra Fast Dynamic Response
- 2.4MHz Switching Frequency Minimizes the External Components
- Internal Soft-start Limits the Inrush Current
- 100% Drop Out Operation
- Output Auto Discharge Function
- Hiccup Mode for Short Circuit Protection
- RoHS Compliant and Halogen Free
- Compact Package: DFN2×2-7

Applications

- Set Top Box
- USB Dongle
- Media Player
- Smart Phone

Typical Applications

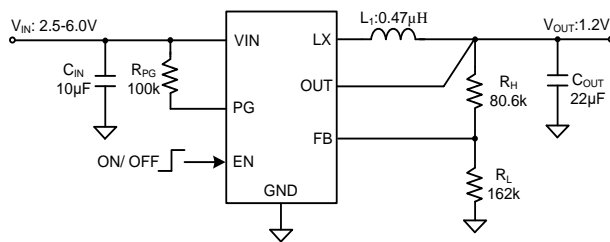

Figure1. Schematic Diagram

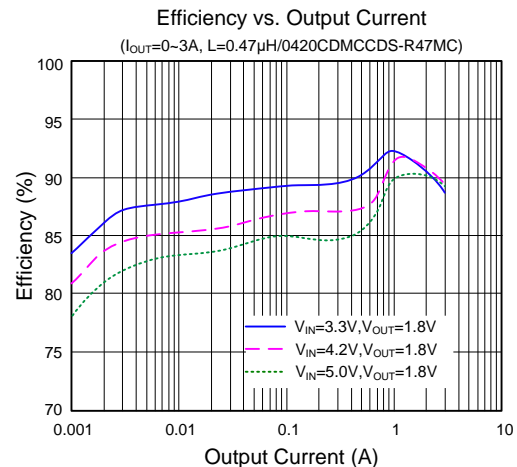
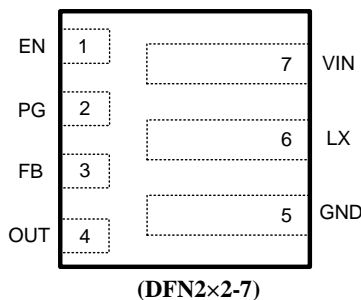

Figure2. Efficiency vs. Output Current

Pinout (Top View)



Top Mark: 7Gxyz (device code: 7G, x=year code, y=week code, z=lot number code)

Pin Name	Pin Number	Pin Description
EN	1	Enable control. Pull high to turn on.
PG	2	Power good indicator.
FB	3	Output feedback pin. Connect this pin to the center point of the output resistor divider (as shown in Figure 1) to program the output voltage: $V_{OUT}=0.8 \times (1+R_H/R_L)$.
OUT	4	Output voltage feedback pin, connect to the output capacitor side.
GND	5	Ground pin.
LX	6	Inductor pin. Connect this pin to the switching node of the inductor.
IN	7	Input pin. Decouple this pin to the GND pin with at least a 10 μ F ceramic capacitor.

Absolute Maximum Ratings (Note 1)

Supply Input Voltage	-0.3V to 7.0V
EN, PG, FB, OUT	-0.3V to $V_{IN} + 0.3V$
LX Voltage	-0.3V ^{(*)1} to 6.5V ^{(*)2}
Power Dissipation, P_D @ $T_A = 25^\circ C$, DFN2x2-7	2.86W
Package Thermal Resistance (Note 2)	
θ_{JA}	35°C/W
θ_{JC}	10°C/W
Junction Temperature Range	-40°C~150°C
Lead Temperature (Soldering, 10 sec.)	260°C
Storage Temperature Range	-65°C to 150°C
^{(*)1} LX Voltage Tested Down to -3V <20ns	
^{(*)2} LX Voltage Tested Up to +7.5V <20ns	

Recommended Operating Conditions (Note 3)

Supply Input Voltage	2.5V to 6.0V
Junction Temperature Range	-40°C to 125°C

Electrical Characteristics

($V_{IN} = 3.6V$, $T_J = -40^{\circ}C \sim 125^{\circ}C$. Typical values are at $T_J = 25^{\circ}C$, unless otherwise specified. The values are guaranteed by test, design or statistical correlation.)

Parameter	Symbol	Test Conditions	Min	Typ	Max	Unit
Input Voltage Range	V_{IN}		2.5		6.0	V
Input UVLO Falling Threshold	$V_{UVLO, FALLING}$		2.1	2.2	2.3	V
Input UVLO Hysteresis	V_{HYS}			200		mV
Quiescent Current	I_Q	$V_{FB}=105\% \times V_{REF}$, $T_J=25^{\circ}C$		23	35	μA
Shutdown Current	I_{SHDN}	$V_{EN}=0$, $T_J=25^{\circ}C$		0.1	1	μA
Feedback Reference Voltage	V_{REF}	$I_{OUT}=1A$, CCM	0.788	0.8	0.812	V
Output Discharge Resistor	R_{DIS}			260		Ω
Top FET R_{ON}	$R_{DS(ON)1}$			31		m Ω
Bottom FET R_{ON}	$R_{DS(ON)2}$			23		m Ω
EN Input Voltage High	$V_{EN,H}$		1.0			V
EN Input Voltage Low	$V_{EN,L}$				0.4	V
EN Pull Down Resistance	R_{EN}			400		k Ω
Power Good Threshold	V_{PG}	V_{FB} falling, PG from high to low	87	90	93	% V_{REF}
		V_{FB} rising, PG from low to high	93	95	98	
Min On Time	$t_{ON,MIN}$			50		ns
Maximum Duty Cycle	D_{MAX}		100			%
Soft-start Time	t_{SS}	From EN high to 95% of V_{OUT} nominal		0.8		ms
Switching Frequency	f_{SW}			2.4		MHz
Top FET Current Limit	$I_{LIM, TOP}$		3.7	4.6	5.5	A
Bottom FET Current Limit	$I_{LIM, BOT}$		3.0			A
Thermal Shutdown Temperature	T_{SD}			150		$^{\circ}C$
Thermal Shutdown Hysteresis	T_{HYS}			20		$^{\circ}C$

Note 1: Stresses beyond the “Absolute Maximum Ratings” may cause permanent damage to the device. These are stress ratings only. Functional operation of the device at these or any other conditions beyond those indicated in the operational sections of the specification is not implied. Exposure to absolute maximum rating conditions for extended periods may affect device reliability.

Note 2: θ_{JA} is measured in the natural convection at $T_A = 25^{\circ}C$ on a low effective single layer thermal conductivity test board of JEDEC 51-3 thermal measurement standard.

Note 3: The device is not guaranteed to function outside its operating conditions.

Typical Performance Characteristics

($T_A=25^\circ\text{C}$, $V_{IN} = 5.0\text{V}$, $L=0.47\mu\text{H}$, $C_{OUT}=22\mu\text{F}$, unless otherwise specified.)

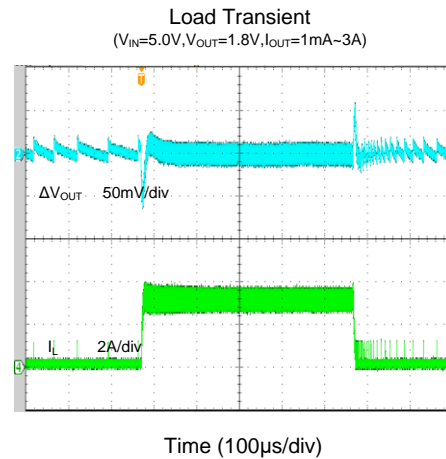
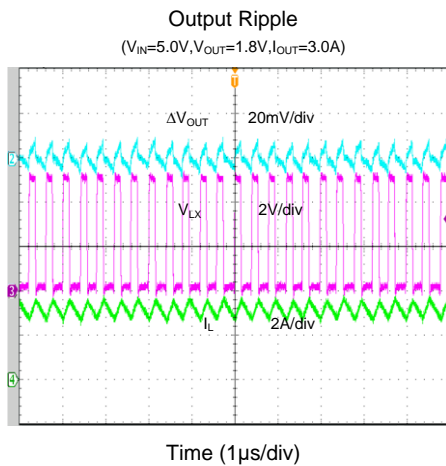
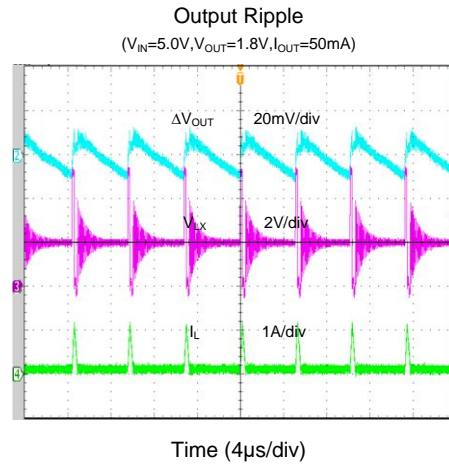
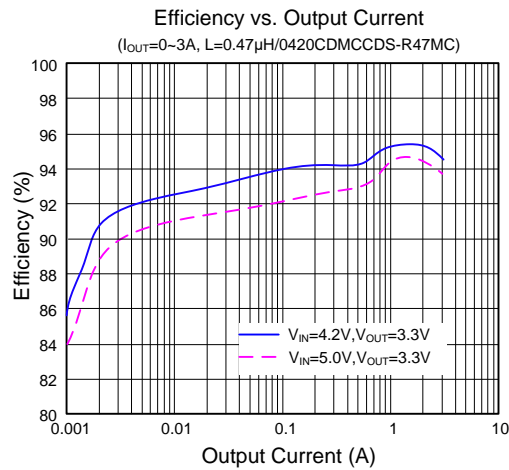
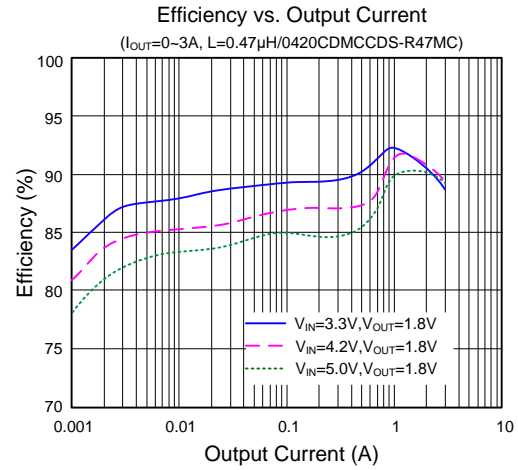
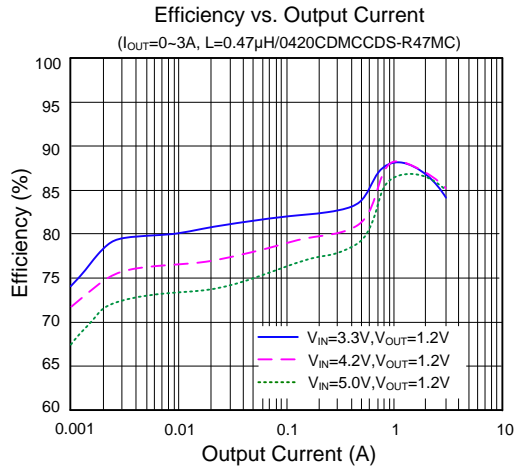

Load Transient
 ($V_{IN}=5.0V, V_{OUT}=1.8V, I_{OUT}=0.3A-3A$)

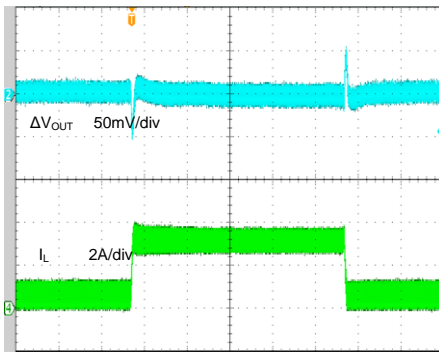

Time (100 μ s/div)

Startup from Enable
 ($V_{IN}=5.0V, V_{OUT}=1.8V, I_{OUT}=3.0A$)

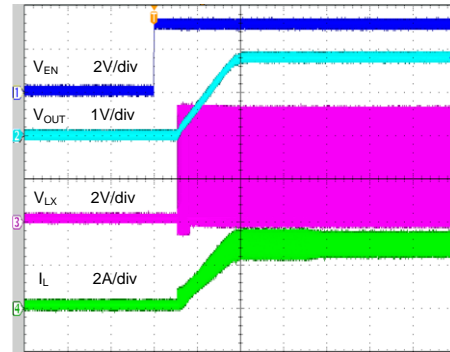

Time (400 μ s/div)

Shutdown from Enable
 ($V_{IN}=5.0V, V_{OUT}=1.8V, I_{OUT}=3.0A$)

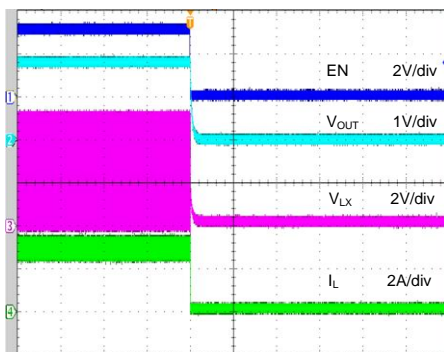

Time (400 μ s/div)

Short Circuit Protection
 ($V_{IN}=5.0V, V_{OUT}=1.8V, I_{OUT}=0A-Short$)

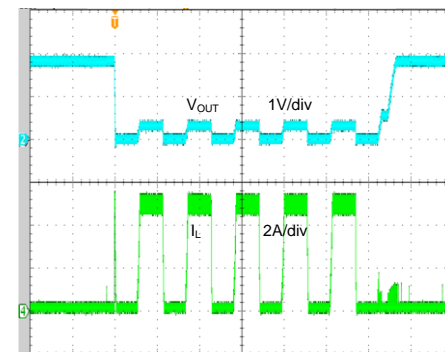

Time (2ms/div)

Short Circuit Protection
 ($V_{IN}=5.0V, V_{OUT}=1.8V, I_{OUT}=3.0A-Short$)

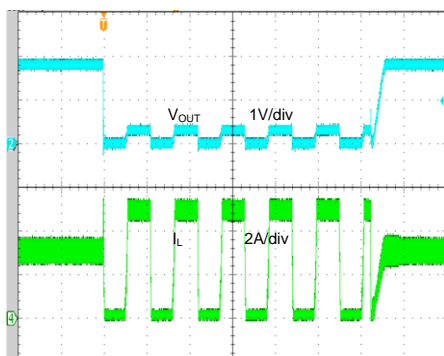

Time (2ms/div)

Operation

The SY26003 is a high efficiency 2.4MHz synchronous step down DC/DC regulator which is capable of delivering up to 3A output currents. It can operate over a wide input voltage range from 2.5V to 6V and integrates main switch and synchronous switch with very low $R_{DS(ON)}$ to minimize the conduction loss.

Low output voltage ripple, small external inductor and capacitor sizes are achieved with 2.4MHz switching frequency.

Applications Information

Because of the high integration in the SY26003, the application circuit based on these regulators is rather simple. Only the input capacitor C_{IN} , the output capacitor C_{OUT} , the output inductor L and the feedback resistors (R_H and R_L) need to be selected for the targeted application specifications.

Feedback Resistor Dividers R_H and R_L

Choose R_H and R_L to program the proper output voltage. To minimize the power consumption under light loads, it is desirable to choose large resistance values for both R_H and R_L . A value of between 10k Ω and 1M Ω is highly recommended for both resistors. If $R_L = 120k\Omega$ is chosen, then R_H can be calculated to be:

$$R_H = \frac{(V_{OUT} - 0.8V) \times R_L}{0.8V}$$

Input Capacitor C_{IN}

A typical X5R or better grade ceramic capacitor with 10V rating and no less than 10uF capacitance is recommended. To minimize the potential noise problem, we place this ceramic capacitor really close to the IN and GND pins. Care should be taken to minimize the loop area formed by C_{IN} , and IN/GND pins.

Output Inductor L

There are several considerations in choosing this inductor.

- 1) Choose the inductance to provide the desired ripple current. It is suggested to choose the ripple current to be about 40% of the maximum output current. The inductance is calculated as:

$$L = \frac{V_{OUT}(1 - V_{OUT}/V_{IN,MAX})}{f_{SW} \times I_{OUT,MAX} \times 40\%}$$

Where f_{SW} is the switching frequency and $I_{OUT, max}$ is the maximum load current.

- 2) The saturation current rating of the inductor must be selected to be greater than the peak inductor current under full load conditions.

$$I_{SAT, MIN} > I_{OUT, MAX} + \frac{V_{OUT}(1 - V_{OUT}/V_{IN,MAX})}{2 \times f_{SW} \times L}$$

- 3) The DCR of the inductor and the core loss at the switching frequency must be low enough to achieve the desired efficiency requirement. It is desirable to choose an inductor with $DCR < 25m\Omega$ to achieve a good overall efficiency.

Minimum Duty Cycle and Maximum Duty Cycle

In the COT architecture, there is no limitation for small duty cycles, since even at very low duty cycles, the switching frequency can be reduced as needed once the on-time is close to the minimum on time, to always ensure a proper operation.

The device can support 100% maximum duty cycle operation under -40°C ~ 125°C condition.

In PFM light load operation, when the duty cycle is up to maximum duty cycle limitation, the device will enter into CCM operation even though the load current is null.

Over Current Protection

With load current increasing, as soon as the high side power FET current gets higher than peak current limit threshold, the high side power FET will turn off and the low side power FET will keep turning on until low side power FET current decrease below the valley current limit threshold. If the load current continues to increase, the output voltage will drop.

Over Voltage Protection

If the DC output voltage is about 3% over the regulation level, both high side power FET and low side power FET will turn off and enter into stand-by mode.

Thermal Shutdown Protection

If the junction temperature of the SY26003 is higher than the thermal shutdown temperature (typical 150°C), the IC will turn off both high side power FET and low side power FET, and then enters thermal shutdown protection mode. It will remain in this state until the junction temperature decreases below 130°C. After exiting this state, the IC auto retries to normal operation.



Layout Design

To achieve a higher efficiency and better noise immunity, following components should be placed close to the IC: C_{IN} , L and C_{OUT} .

1) It is desirable to maximize the PCB copper area connecting to the GND pin to achieve the best thermal and noise performance. Reasonable vias are suggested to be placed underneath the ground pad to

enhance the soldering quality and thermal performance.

2) The decoupling capacitor of V_{IN} must be placed close enough to the pins. The loop area formed by the capacitors and GND must be minimized.

3) The PCB copper area associated with the LX pin must be minimized to improve the noise immunity.

4) The resistor R_{FB} should be placed near the FB pin.

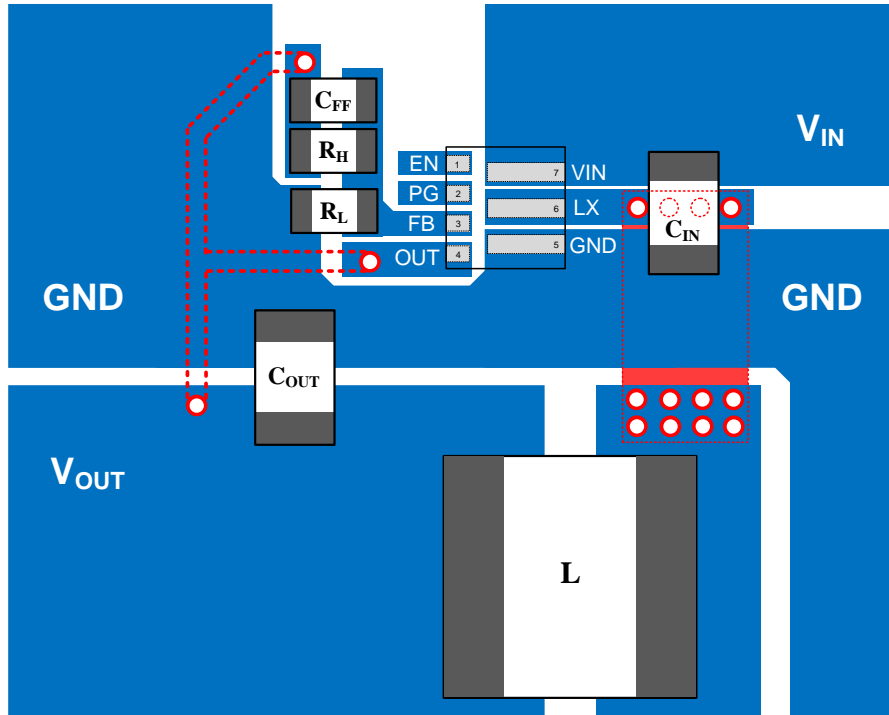
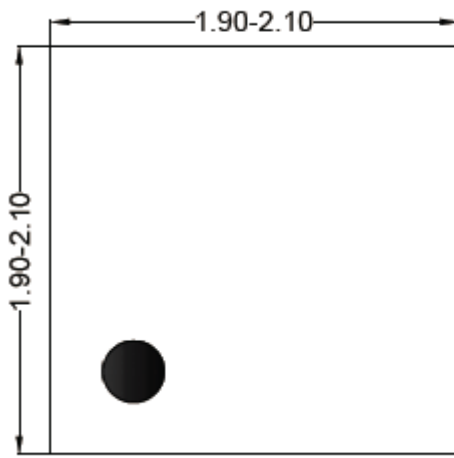
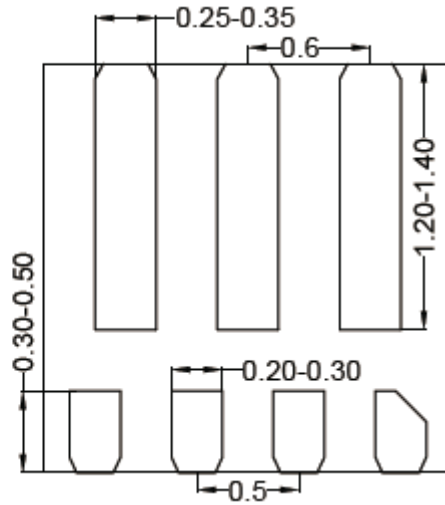

Figure3. PCB Layout Suggestion

DFN2×2-7 Package Outline Drawing



Top view



Bottom view

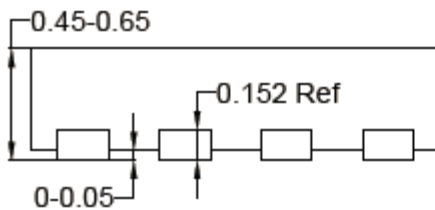

Front view

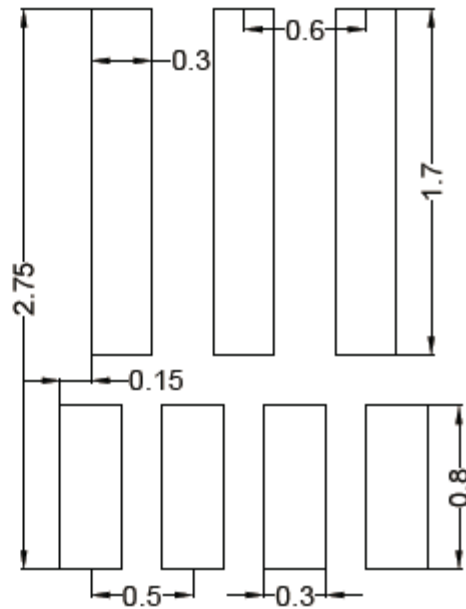

**Recommended PCB layout
(Reference only)**

Notes: 1, All dimension in millimeter and exclude mold flash & metal burr;

Taping & Reel Specification

1. DFN2x2

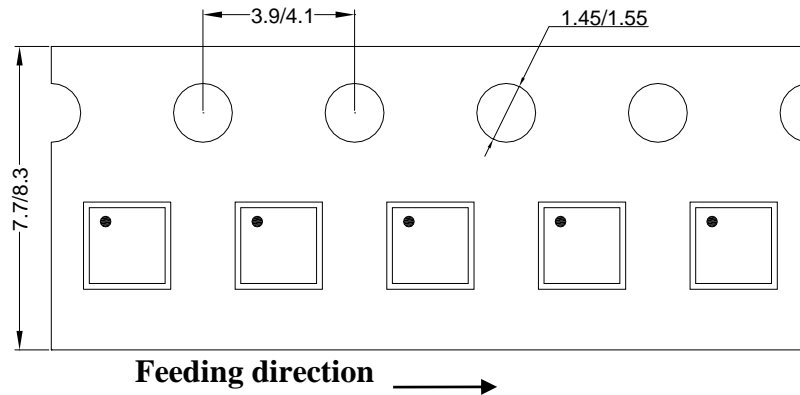

2. Carrier Tape & Reel specification for packages

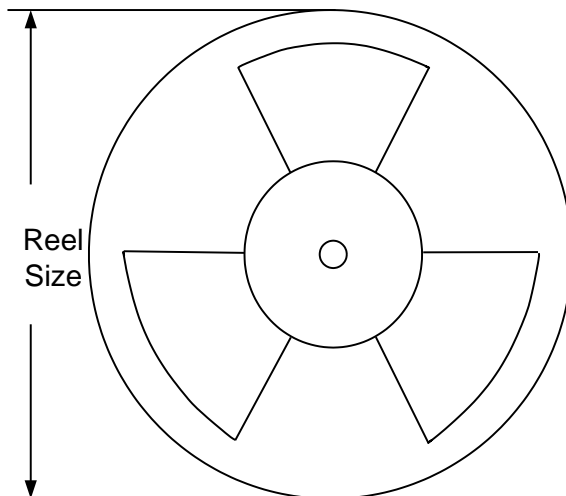

Package types	Tape width (mm)	Pocket pitch(mm)	Reel size (Inch)	Trailer length(mm)	Leader length (mm)	Qty per reel
DFN2x2	8	4	7"	400	160	3000

3. Others: NA



Revision History

The revision history provided is for informational purpose only and is believed to be accurate, however, not warranted. Please make sure that you have the latest revision.

Date	Revision	Change
Dec.29, 2020	Revision 0.9	Initial Release

IMPORTANT NOTICE

1. **Right to make changes.** Silergy and its subsidiaries (hereafter Silergy) reserve the right to change any information published in this document, including but not limited to circuitry, specification and/or product design, manufacturing or descriptions, at any time and without notice. This document supersedes and replaces all information supplied prior to the publication hereof. Buyers should obtain the latest relevant information before placing orders and should verify that such information is current and complete. All semiconductor products are sold subject to Silergy's standard terms and conditions of sale.
2. **Applications.** Application examples that are described herein for any of these products are for illustrative purposes only. Silergy makes no representation or warranty that such applications will be suitable for the specified use without further testing or modification. Buyers are responsible for the design and operation of their applications and products using Silergy products. Silergy or its subsidiaries assume no liability for any application assistance or designs of customer products. It is customer's sole responsibility to determine whether the Silergy product is suitable and fit for the customer's applications and products planned. To minimize the risks associated with customer's products and applications, customer should provide adequate design and operating safeguards. Customer represents and agrees that it has all the necessary expertise to create and implement safeguards which anticipate dangerous consequences of failures, monitor failures and their consequences, lessen the likelihood of failures that might cause harm and take appropriate remedial actions. Silergy assumes no liability related to any default, damage, costs or problem in the customer's applications or products, or the application or use by customer's third-party buyers. Customer will fully indemnify Silergy, its subsidiaries, and their representatives against any damages arising out of the use of any Silergy components in safety-critical applications. It is also buyers' sole responsibility to warrant and guarantee that any intellectual property rights of a third party are not infringed upon when integrating Silergy products into any application. Silergy assumes no responsibility for any said applications or for any use of any circuitry other than circuitry entirely embodied in a Silergy product.
3. **Limited warranty and liability.** Information furnished by Silergy in this document is believed to be accurate and reliable. However, Silergy makes no representation or warranty, expressed or implied, as to the accuracy or completeness of such information and shall have no liability for the consequences of use of such information. In no event shall Silergy be liable for any indirect, incidental, punitive, special or consequential damages, including but not limited to lost profits, lost savings, business interruption, costs related to the removal or replacement of any products or rework charges, whether or not such damages are based on tort or negligence, warranty, breach of contract or any other legal theory. Notwithstanding any damages that customer might incur for any reason whatsoever, Silergy' aggregate and cumulative liability towards customer for the products described herein shall be limited in accordance with the Standard Terms and Conditions of Sale of Silergy.
4. **Suitability for use.** Customer acknowledges and agrees that it is solely responsible for compliance with all legal, regulatory and safety-related requirements concerning its products, and any use of Silergy components in its applications, notwithstanding any applications-related information or support that may be provided by Silergy. Silergy products are not designed, authorized or warranted to be suitable for use in life support, life-critical or safety-critical systems or equipment, nor in applications where failure or malfunction of an Silergy product can reasonably be expected to result in personal injury, death or severe property or environmental damage. Silergy assumes no liability for inclusion and/or use of Silergy products in such equipment or applications and therefore such inclusion and/or use is at the customer's own risk.
5. **Terms and conditions of commercial sale.** Silergy products are sold subject to the standard terms and conditions of commercial sale, as published at <http://www.silergy.com/stdterms>, unless otherwise agreed in a valid written individual agreement specifically agreed to in writing by an authorized officer of Silergy. In case an individual agreement is concluded only the terms and conditions of the respective agreement shall apply. Silergy hereby expressly objects to and denies the application of any customer's general terms and conditions with regard to the purchase of Silergy products by the customer.
6. **No offer to sell or license.** Nothing in this document may be interpreted or construed as an offer to sell products that is open for acceptance or the grant, conveyance or implication of any license under any copyrights, patents or other industrial or intellectual property rights. Silergy makes no representation or warranty that any license, either express or implied, is granted under any patent right, copyright, mask work right, or other intellectual property right. Information published by Silergy regarding third-party products or services does not constitute a license to use such products or services or a warranty or endorsement thereof. Use of such information may require a license from a third party under the patents or other intellectual property of the third party, or a license from Silergy under the patents or other intellectual property of Silergy.

For more information, please visit: www.silergy.com

©2021 Silergy Corp.

All Rights Reserved.