

Single Rail, 6 Phase Controller

1 General Description

The SQ51202 single rail 6 phase digital controller provides power for high performance SoCs. Silergy's unique ripple-based control with built-in flexible loop compensation provides fast transient response for high current applications. The controller supports integrated power stages that provide current and temperature sense. Additionally, SQ51202's programmable PWM driving configuration provides flexibility when used with DrMOS devices from multiple vendors.

The SQ51202 supports the PMBus® communication interface and it is compatible with 1.8V/3.3V interface levels. Complying with PMBus, SQ51202 supports the following features: dynamic voltage scaling (DVS), reporting telemetry information of voltage, current, temperature, fault/warning status to the host, configurable fault response and thresholds. All programmable parameters can be stored in a non-volatile memory.

2 Features

- Flexible Phase Assignment and Arbitrary Firing Sequence, $N \leq 6$
- Differential Remote Sense
- Output Voltage Regulation Range Covers:
 - 0.25~1.52V in 5mV Table
 - 0.5~2.0V in 10mV Table
 - 0.25~2V in Linear Mode (LSB=1.953mV)
- Programmable Soft-Start Slew Rate and Voltage Positioning Slew Rate
- Flexible Pin-Strap Settings Including:
 - Multiple(8) Customer Configurations
 - 5mV/10mV VID Table
 - 4 PMBus Addresses with Additional 5 Bit Programmable Offset
 - 8-Bit Boot Voltage
- PMBus 1.3.1 Compliant, 1.8/3.3V Signaling:
 - System Configuration
 - DVS using VOUT_COMMAND
 - Operation Control and Fault Handling
 - Status Reporting and Telemetry

- Flexible PWM Driver Design to Support SPS from Multiple Vendors
- Integrated Programmable Loop Compensation, Minimal External Components
- Adjustable Current Balancing with Optional Thermal Balancing Offsets
- Autonomous Phase Shedding with Enhanced Transient Performance
- Advanced Protection Scheme with Programmable Response and Thresholds
 - Fault Response: Latched Shutdown, Hiccup, Autonomous Recovery
 - IUVP, IOVP, OUV, OOV (Fix and Tracking)
 - OCP
 - OTP, DRV_FLT, DRV_NONRDY Protection
 - Driver UVLO and Limp Mode fault detection
 - SPS Current Sharing Protection
 - Pulse by Pulse Current Limit
 - Open/Short Voltage Sense Line Detection
 - Per-Phase Negative Current Limit
- Internal NVM to Store Up to 8 Customer Configurations
- Switching Frequency Range from 300kHz to 1.2MHz with Frequency Compensation
- Single +3.3V Supply Operation
- 48-Lead QFN7x7 0.5mm Pitch Package

3 Applications

- Application-Specific ASIC power
- Core Routers and Switches
- High Performance XPU/FPGA Power
- High Density Power Solutions

4 Typical Application

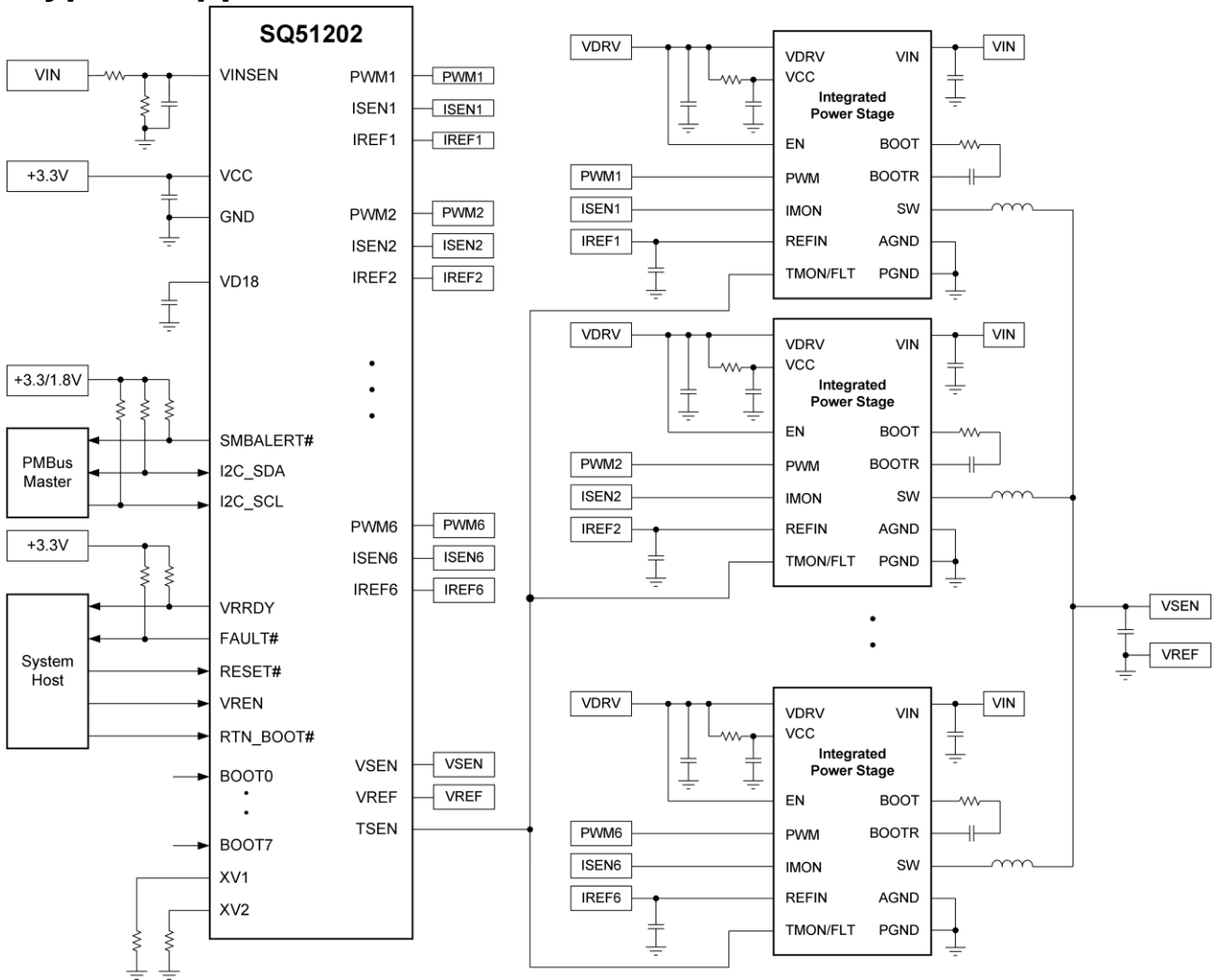

Figure1 Application Diagram -High Power rail using SQ51202 and 6 power stages



5 Ordering Information

Ordering Part Number	Package Type	Top Mark
SQ51202QJQ	QFN7x7-48 RoHS Compliant and Halogen Free	GMAxyz

Device code: GMA

x=year code, y=week code, z= lot number code

6 Package Outline Drawing

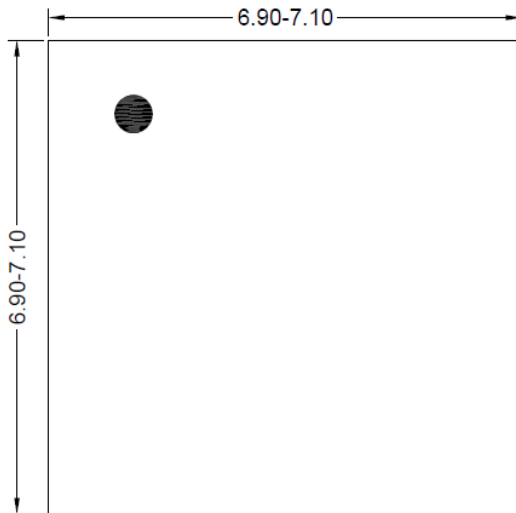

Top View

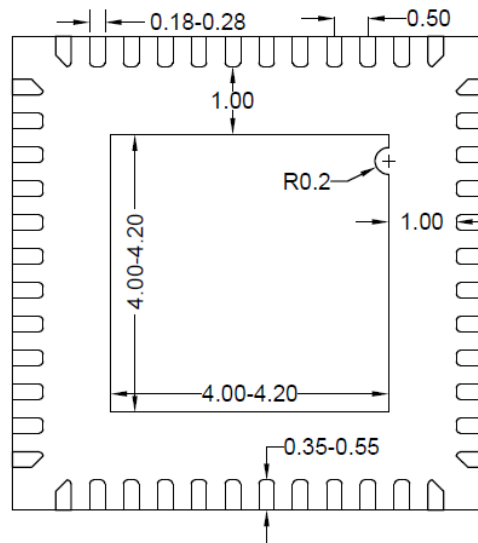

Side view

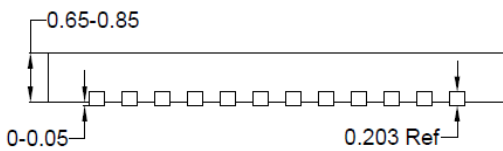

Bottom View

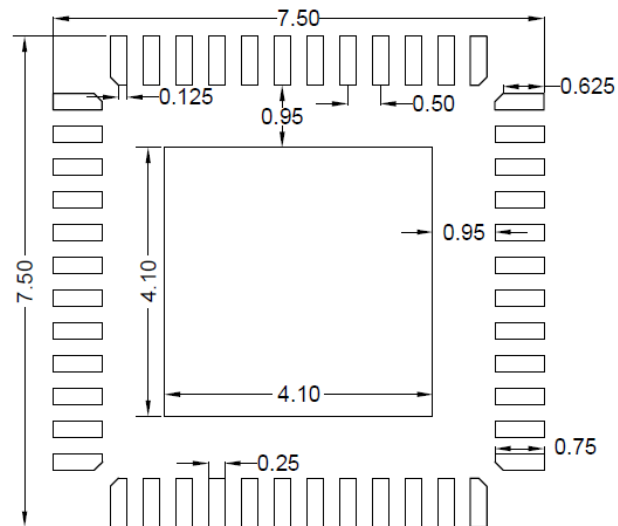

Recommended PCB Layout
Only for reference

Notes: All dimension in millimeter and exclude mold flash & metal burr.

7 Tape and Reel information

1. Tape Dimensions and Pin 1 Orientation

QFN7x7

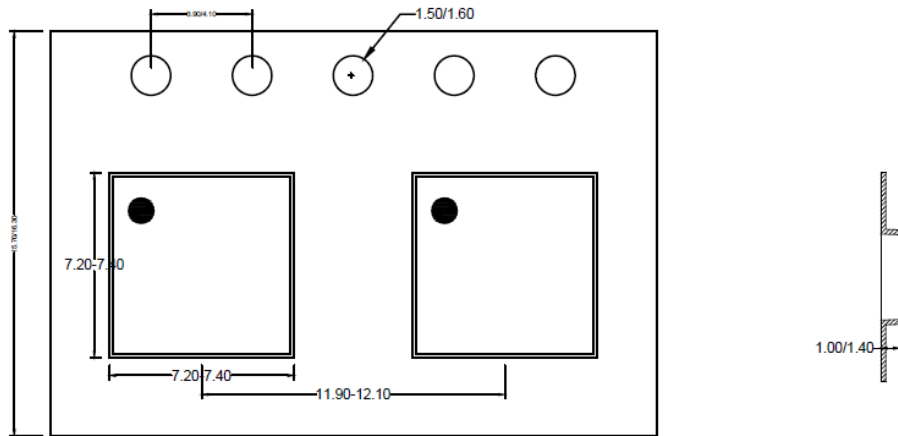

Feeding direction →

2. Reel Dimensions

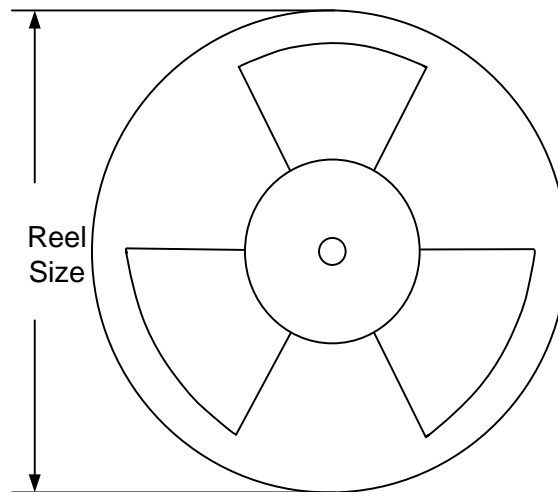

Package types	Tape width (mm)	Pocket pitch(mm)	Reel size (Inch)	Trailer length(mm)	Leader length (mm)	Qty per reel
QFN7x7	16	12	13"	400	400	3000

IMPORTANT NOTICE

- 1. Right to make changes.** Silergy and its subsidiaries (hereafter Silergy) reserve the right to change any information published in this document, including but not limited to circuitry, specification and/or product design, manufacturing or descriptions, at any time and without notice. This document supersedes and replaces all information supplied prior to the publication hereof. Buyers should obtain the latest relevant information before placing orders and should verify that such information is current and complete. All semiconductor products are sold subject to Silergy's standard terms and conditions of sale.
- 2. Applications.** Application examples that are described herein for any of these products are for illustrative purposes only. Silergy makes no representation or warranty that such applications will be suitable for the specified use without further testing or modification. Buyers are responsible for the design and operation of their applications and products using Silergy products. Silergy or its subsidiaries assume no liability for any application assistance or designs of customer products. It is customer's sole responsibility to determine whether the Silergy product is suitable and fit for the customer's applications and products planned. To minimize the risks associated with customer's products and applications, customer should provide adequate design and operating safeguards. Customer represents and agrees that it has all the necessary expertise to create and implement safeguards which anticipate dangerous consequences of failures, monitor failures and their consequences, lessen the likelihood of failures that might cause harm and take appropriate remedial actions. Silergy assumes no liability related to any default, damage, costs or problem in the customer's applications or products, or the application or use by customer's third-party buyers. Customer will fully indemnify Silergy, its subsidiaries, and their representatives against any damages arising out of the use of any Silergy components in safety-critical applications. It is also buyers' sole responsibility to warrant and guarantee that any intellectual property rights of a third party are not infringed upon when integrating Silergy products into any application. Silergy assumes no responsibility for any said applications or for any use of any circuitry other than circuitry entirely embodied in a Silergy product.
- 3. Limited warranty and liability.** Information furnished by Silergy in this document is believed to be accurate and reliable. However, Silergy makes no representation or warranty, expressed or implied, as to the accuracy or completeness of such information and shall have no liability for the consequences of use of such information. In no event shall Silergy be liable for any indirect, incidental, punitive, special or consequential damages, including but not limited to lost profits, lost savings, business interruption, costs related to the removal or replacement of any products or rework charges, whether or not such damages are based on tort or negligence, warranty, breach of contract or any other legal theory. Notwithstanding any damages that customer might incur for any reason whatsoever, Silergy' aggregate and cumulative liability towards customer for the products described herein shall be limited in accordance with the Standard Terms and Conditions of Sale of Silergy.
- 4. Suitability for use.** Customer acknowledges and agrees that it is solely responsible for compliance with all legal, regulatory and safety-related requirements concerning its products, and any use of Silergy components in its applications, notwithstanding any applications-related information or support that may be provided by Silergy. Silergy products are not designed, authorized or warranted to be suitable for use in life support, life-critical or safety-critical systems or equipment, nor in applications where failure or malfunction of a Silergy product can reasonably be expected to result in personal injury, death or severe property or environmental damage. Silergy assumes no liability for inclusion and/or use of Silergy products in such equipment or applications and therefore such inclusion and/or use is at the customer's own risk.
- 5. Terms and conditions of commercial sale.** Silergy products are sold subject to the standard terms and conditions of commercial sale, as published at <http://www.silergy.com/stdterms>, unless otherwise agreed in a valid written individual agreement specifically agreed to in writing by an authorized officer of Silergy. In case an individual agreement is concluded only the terms and conditions of the respective agreement shall apply. Silergy hereby expressly objects to and denies the application of any customer's general terms and conditions with regard to the purchase of Silergy products by the customer.
- 6. No offer to sell or license.** Nothing in this document may be interpreted or construed as an offer to sell products that is open for acceptance or the grant, conveyance or implication of any license under any copyrights, patents or other industrial or intellectual property rights. Silergy makes no representation or warranty that any license, either express or implied, is granted under any patent right, copyright, mask work right, or other intellectual property right. Information published by Silergy regarding third-party products or services does not constitute a license to use such products or services or a warranty or endorsement thereof. Use of such information may require a license from a third party under the patents or other intellectual property of the third party, or a license from Silergy under the patents or other intellectual property of Silergy.

For more information, please visit: www.silergy.com

©2024 Silergy Corp.

All Rights Reserved.