

General Description

The SYCT-3 is a family of high accuracy galvanically isolated Hall-effect current sensor ICs for ± 50 to ± 250 A. Current sensing supports both unidirectional and bidirectional, DC and AC currents. Applied current generates a magnetic field, then converted by into a proportional analog voltage. The bandwidth is up to 170kHz and the response time is 3 μ s.

A precise, proportional output voltage is provided by the high accuracy, good linearity, low temperature drift Hall IC, which is programmed for accuracy at the factory.

The package offers four options, PFF/PSF/PSS/SMT, for easy implementation, which the PFF is the standard package.

The SYCT-3 is suitable for insulation, small size with low heat generation applications, including automotive, industrial, and communications systems.

Features

- 3.3V single supply
- Wide Hall current sensing range:
 - Bidirectional: $\pm 50 \sim \pm 250$ A
 - Unidirectional: 50 ~ 250A
- 170kHz typical bandwidth, response time 0.7 μ s
- UL60950-1(ed.2) certified
 - Dielectric Strength Test Voltage = 4800V_{RMS}
 - Working Voltage for Basic Isolation = 700V_{RMS}
 - Working Voltage for Reinforced Isolation = 450V_{RMS}
- Ultralow primary conductor resistance for power loss
- Factory-trimmed for high accuracy
- Package: PFF/PSF/PSS/SMT

Applications

- EV/HEV charger and DC-DC power supply
- Photovoltaic inverter power supply and UPS
- Motor control and frequency converter
- Communication and server power supply

Typical Application

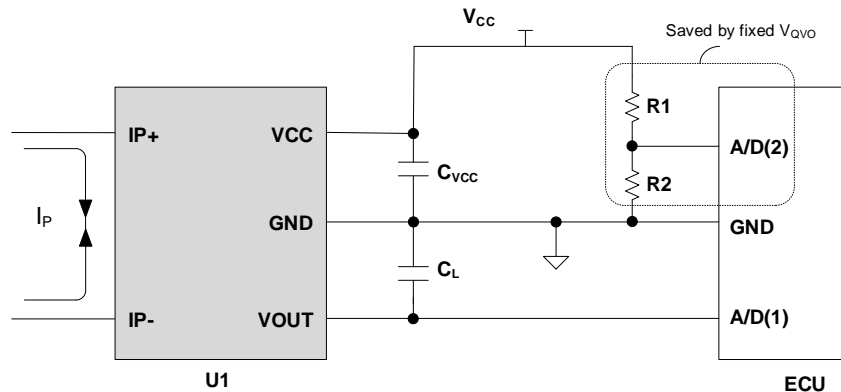

Figure 1. Typical Application Circuit

Package Type



PFF
(Standard)



PSF



PSS



SMT

Ordering Information

Please indicate the package type in the suffix when ordering, such as SYCT050BR-3PSF.
If the packaging type is not specified, the default is to the standard (PFF) package.

Part Number	Architecture	I _p (A)	Sensitivity(mV/A)	V _{Qvo} (V)	T _A (°C)
SYCT050BR-3	Bidirectional	±50	26.4	V _{cc} /2	-40 to 125
SYCT050BF-3	Bidirectional	±50	26.4	1.65	-40 to 125
SYCT050UF-3	Unidirectional	50	49.4	0.5	-40 to 125
SYCT100BR-3	Bidirectional	±100	13.2	V _{cc} /2	-40 to 125
SYCT100BF-3	Bidirectional	±100	13.2	1.65	-40 to 125
SYCT100UF-3	Unidirectional	100	24.7	0.5	-40 to 125
SYCT150BR-3	Bidirectional	±150	8.8	V _{cc} /2	-40 to 105
SYCT150BF-3	Bidirectional	±150	8.8	1.65	-40 to 105
SYCT150UF-3	Unidirectional	150	16.5	0.5	-40 to 105
SYCT200BR-3	Bidirectional	±200	6.6	V _{cc} /2	-40 to 85
SYCT200BF-3	Bidirectional	±200	6.6	1.65	-40 to 85
SYCT200UF-3	Unidirectional	200	12.4	0.5	-40 to 85
SYCT250BR-3	Bidirectional	±250	5.3	V _{cc} /2	-40 to 85
SYCT250BF-3	Bidirectional	±250	5.3	1.65	-40 to 85
SYCT250UF-3	Unidirectional	250	9.9	0.5	-40 to 85

Pinout (Top View)

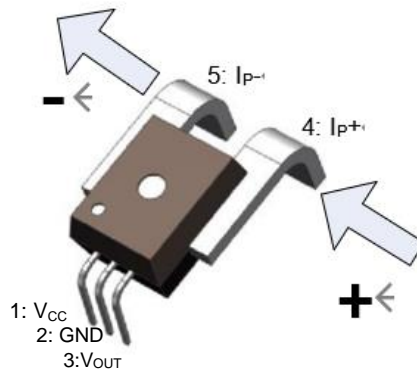

Pin Number	Pin Name	Pin Description
1	VCC	Power supply pin.
2	GND	Ground pin.
3	VOUT	Analog output pin.
4	IP+	Positive terminals for sensing current.
5	IP-	Negative terminals for sensing current.

Absolute Maximum Ratings (Note 1)

Supply Input Voltage	-----	-0.3 to 4.6V
Supply Input Current	-----	18mA
Output Voltage	-----	0.15 to VCC-0.15V
Output Current (Note 2)	-----	±40 mA
Ambient Temperature Range	-----	-40 to 125°C
Maximum Junction Temperature	-----	165°C
Storage Temperature Range	-----	-55 to 150°C

Recommended Operating Conditions (Note 3)

Supply Input Voltage	-----	3.0 to 3.6V
----------------------	-------	-------------

Isolation Characteristics

Characteristic	Symbol	Notes	Rating	Unit
Dielectric Strength Test Voltage (Note 4)	V _{ISO}	Agency type-tested for 60 seconds per UL standard 60950-1 (edition 2)	4800	V _{RMS}
Working Voltage for Basic Isolation	V _{WVBI}	For basic (single) isolation per UL standard 60950-1 (edition 2)	990	V _{PK}
			700	V _{RMS}
Working Voltage for Reinforced Isolation	V _{WVRI}	For reinforced (double) isolation per UL standard 60950-1 (edition 2)	636	V _{PK}
			450	V _{RMS}

Electrical Characteristics

 ($V_{CC} = 3.3V$, $C_{VCC} = 0.1\mu F$, $T_A = -40$ to $125^\circ C$, unless otherwise specified)

Parameter	Symbol	Test Conditions	Min	Typ.	Max	Unit
Supply Voltage	V_{CC}	SYCT-xxxR-3	3.0	3.3	3.6	V
		SYCT-xxxF-3	3.14	3.3	3.46	
Supply Current	I_{CC}	$R_L \geq 10k\Omega$		13	18	mA
Power on Delay Time	T_{POD}	$T_A = 25^\circ C$		80		μs
Zero Current Output Voltage (Note 5)	V_{QVO}	SYCT-3xxxBR, $T_A = 25^\circ C$		$V_{CC}/2$		V
		SYCT-3xxxBF, $T_A = 25^\circ C$		1.65		V
		SYCT-3xxxUF, $T_A = 25^\circ C$		0.50		V
Output Voltage Range @ I_P	$V_{OUT} - V_{QVO}$	SYCT-3xxxBR, $T_A = 25^\circ C$		± 1.32		V
		SYCT-3xxxBF, $T_A = 25^\circ C$		± 1.32		V
		SYCT-3xxxUF, $T_A = 25^\circ C$		2.47		V
Zero Current Output Ratiometry Error	E_{RAT}		-0.3		0.3	%
Output Load Resistance	R_L	V_{OUT} to V_{CC} or GND	10			$k\Omega$
Output Load Capacitance	C_L	V_{OUT} to GND	6		100	nF
Response Time	t_{RES}	$T_A = 25^\circ C$, $C_L = 1nF$		3		μs
Bandwidth	BW	Small signal -3dB, $C_L = 1nF$, $T_A = 25^\circ C$	120	170		kHz
DC Output Impedance	R_{OUT}	$T_A = 25^\circ C$		8		Ω

Note 1: Stresses beyond the “Absolute Maximum Ratings” may cause permanent damage to the device. These are stress ratings only. Functional operation of the device at these or any other conditions beyond those indicated in the operational sections of the specification is not implied. Exposure to absolute maximum rating conditions for extended periods may affect device reliability.

Note 2: Maximum survivable sink or source current on the VOUT pin.

Note 3: The device is not guaranteed to function outside its operating conditions.

Note 4: 60-second test is only for UL test; Tested in production against UL60950-1 2nd Edition.

Note 5: The current sensing ranges (050/100/150/200/250) are represented by xxx.

SYCT050BR-3 and SYCT050BF-3 Performance Characteristics

 (V_{CC} = 3.3V, C_{VCC} = 0.1μF, T_A = -40 to 125°C, unless otherwise specified)

Parameter	Symbol	Condition	Min	Typ.	Max	Unit
Nominal Performance						
Current Sensing Range	I _P		-50		50	A
Sensitivity	Sens			26.4		mV/A
Accuracy Performance						
Sensitivity Error	E _{SENS}	T _A =25°C	-1		1	%
Voltage Offset Error	V _{OE}	I _P =0A, T _A = 25°C	-4	±3	4	mV
		I _P =0A	-20	±8	20	mV
Magnetic Offset Error	I _{OM}	I _P =0A, T _A = 25°C, after excursion of 50A		160	320	mA
Offset Current	I _{OE}	T _A = 25°C			0.3	A
Linearity Error	E _{LIN}	Full scale of I _P	-1	0.5	1	%
Total Output Error	E _{TOT, H}	Full scale of I _P , T _A = 25 to 125°C	-2		2	%
	E _{TOT, L}	Full scale of I _P , T _A = -40 to 25°C	-2		2	%

SYCT050UF-3 Performance Characteristics

 (V_{CC} = 3.3V, C_{VCC} = 0.1μF, T_A = -40 to 125°C, unless otherwise specified)

Parameter	Symbol	Condition	Min	Typ.	Max	Unit
Nominal Performance						
Current Sensing Range	I _P		0		50	A
Sensitivity	Sens			49.4		mV/A
Accuracy Performance						
Sensitivity Error	E _{SENS}	T _A =25°C	-1		1	%
Voltage Offset Error	V _{OE}	I _P =0A, T _A = 25°C	-4	±3	4	mV
		I _P =0A	-20	±8	20	mV
Magnetic Offset Error	I _{OM}	I _P =0A, T _A = 25°C, after excursion of 50A		100	200	mA
Offset Current	I _{OE}	T _A = 25°C			0.15	A
Linearity Error	E _{LIN}	Full scale of I _P	-1	0.5	1	%
Total Output Error	E _{TOT, H}	Full scale of I _P , T _A = 25 to 125°C	-2		2	%
	E _{TOT, L}	Full scale of I _P , T _A = -40 to 25°C	-2		2	%

SYCT100BR-3 and SYCT100BF-3 Performance Characteristics

 (V_{CC} = 3.3V, C_{VCC} = 0.1μF, T_A = -40 to 125°C, unless otherwise specified)

Parameter	Symbol	Condition	Min	Typ.	Max	Unit
Nominal Performance						
Current Sensing Range	I _P		-100		100	A
Sensitivity	Sens			13.2		mV/A
Accuracy Performance						
Sensitivity Error	E _{SENS}	T _A =25°C	-1		1	%
Voltage Offset Error	V _{OE}	I _P =0A, T _A = 25°C	-4	±3	4	mV
		I _P =0A	-20	±8	20	mV
Magnetic Offset Error	I _{OM}	I _P =0A, T _A = 25°C, after excursion of 100A		200	300	mA
Offset Current	I _{OE}	T _A = 25°C			0.5	A
Linearity Error	E _{LIN}	Full scale of I _P	-1	0.5	1	%
Total Output Error	E _{TOT, H}	Full scale of I _P , T _A = 25 to 125°C	-2		2	%
	E _{TOT, L}	Full scale of I _P , T _A = -40 to 25°C	-2		2	%

SYCT100UF-3 Performance Characteristics

 (V_{CC} = 3.3V, C_{VCC} = 0.1μF, T_A = -40 to 125°C, unless otherwise specified)

Parameter	Symbol	Condition	Min	Typ.	Max	Unit
Nominal Performance						
Current Sensing Range	I _P		0		100	A
Sensitivity	Sens			24.7		mV/A
Accuracy Performance						
Sensitivity Error	E _{SENS}	T _A =25°C	-1		1	%
Voltage Offset Error	V _{OE}	I _P =0A, T _A = 25°C	-4	±3	4	mV
		I _P =0A	-20	±8	20	mV
Magnetic Offset Error	I _{OM}	I _P =0A, T _A = 25°C, after excursion of 100A		100	150	mA
Offset Current	I _{OE}	T _A = 25°C			0.25	A
Linearity Error	E _{LIN}	Full scale of I _P	-1	0.5	1	%
Total Output Error	E _{TOT, H}	Full scale of I _P , T _A = 25 to 125°C	-2		2	%
	E _{TOT, L}	Full scale of I _P , T _A = -40 to 25°C	-2		2	%

SYCT150BR-3 and SYCT150BF-3 Performance Characteristics

 (V_{CC} = 3.3V, C_{VCC} = 0.1μF, T_A = -40 to 105°C, unless otherwise specified)

Parameter	Symbol	Condition	Min	Typ.	Max	Unit
Nominal Performance						
Current Sensing Range	I _P		-150		150	A
Sensitivity	Sens			8.8		mV/A
Accuracy Performance						
Sensitivity Error	E _{SENS}	T _A =25°C	-1		1	%
Voltage Offset Error	V _{OE}	I _P =0A, T _A = 25°C	-4	±3	4	mV
		I _P =0A	-20	±8	20	mV
Magnetic Offset Error	I _{OM}	I _P =0A, T _A = 25°C, after excursion of 150A		300	400	mA
Offset Current	I _{OE}	T _A = 25°C			0.75	A
Linearity Error	E _{LIN}	Full scale of I _P	-1	0.5	1	%
Total Output Error	E _{TOT, H}	Full scale of I _P , T _A = 25 to 105°C	-2		2	%
	E _{TOT, L}	Full scale of I _P , T _A = -40 to 25°C	-2		2	%

SYCT150UF-3 Performance Characteristics

 (V_{CC} = 3.3V, C_{VCC} = 0.1μF, T_A = -40 to 105°C, unless otherwise specified)

Parameter	Symbol	Condition	Min	Typ.	Max	Unit
Nominal Performance						
Current Sensing Range	I _P		0		150	A
Sensitivity	Sens			16.5		mV/A
Accuracy Performance						
Sensitivity Error	E _{SENS}	T _A =25°C	-1		1	%
Voltage Offset Error	V _{OE}	I _P =0A, T _A = 25°C	-4	±3	4	mV
		I _P =0A	-20	±8	20	mV
Magnetic Offset Error	I _{OM}	I _P =0A, T _A = 25°C, after excursion of 150A		180	240	mA
Offset Current	I _{OE}	T _A = 25°C			0.45	A
Linearity Error	E _{LIN}	Full scale of I _P	-1	0.5	1	%
Total Output Error	E _{TOT, H}	Full scale of I _P , T _A = 25 to 105°C	-2		2	%
	E _{TOT, L}	Full scale of I _P , T _A = -40 to 25°C	-2		2	%

SYCT200BR-3 and SYCT200BF-3 Performance Characteristics

 (V_{CC} = 3.3V, C_{VCC} = 0.1μF, T_A = -40 to 85°C, unless otherwise specified)

Parameter	Symbol	Condition	Min	Typ.	Max	Unit
Nominal Performance						
Current Sensing Range	I _P		-200		200	A
Sensitivity	Sens			6.6		mV/A
Accuracy Performance						
Sensitivity Error	E _{SENS}	T _A =25°C	-1		1	%
Voltage Offset Error	V _{OE}	I _P =0A, T _A = 25°C	-4	±3	4	mV
		I _P =0A	-20	±8	20	mV
Magnetic Offset Error	I _{OM}	I _P =0A, T _A = 25°C, after excursion of 200A		400	500	mA
Offset Current	I _{OE}	T _A = 25°C			1	A
Linearity Error	E _{LIN}	Full scale of I _P	-1	0.5	1	%
Total Output Error	E _{TOT, H}	Full scale of I _P , T _A = 25 to 85°C	-2		2	%
	E _{TOT, L}	Full scale of I _P , T _A = -40 to 25°C	-2		2	%

SYCT200UF-3 Performance Characteristics

 (V_{CC} = 3.3V, C_{VCC} = 0.1μF, T_A = -40 to 85°C, unless otherwise specified)

Parameter	Symbol	Condition	Min	Typ.	Max	Unit
Nominal Performance						
Current Sensing Range	I _P		0		200	A
Sensitivity	Sens			12.4		mV/A
Accuracy Performance						
Sensitivity Error	E _{SENS}	T _A =25°C	-1		1	%
Voltage Offset Error	V _{OE}	I _P =0A, T _A = 25°C	-4	±3	4	mV
		I _P =0A	-20	±8	20	mV
Magnetic Offset Error	I _{OM}	I _P =0A, T _A = 25°C, after excursion of 200A		200	250	mA
Offset Current	I _{OE}	T _A = 25°C			0.5	A
Linearity Error	E _{LIN}	Full scale of I _P	-1	0.5	1	%
Total Output Error	E _{TOT, H}	Full scale of I _P , T _A = 25 to 85°C	-2		2	%
	E _{TOT, L}	Full scale of I _P , T _A = -40 to 25°C	-2		2	%

SYCT250BR-3 and SYCT250BF-3 Performance Characteristics

 (V_{CC} = 3.3V, C_{VCC} = 0.1μF, T_A = -40 to 85°C, unless otherwise specified)

Parameter	Symbol	Condition	Min	Typ.	Max	Unit
Nominal Performance						
Current Sensing Range	I _P		-250		250	A
Sensitivity	Sens			5.3		mV/A
Accuracy Performance						
Sensitivity Error	E _{SENS}	T _A =25°C	-1		1	%
Voltage Offset Error	V _{OE}	I _P =0A, T _A = 25°C	-4	±3	4	mV
		I _P =0A	-20	±8	20	mV
Magnetic Offset Error	I _{OM}	I _P =0A, T _A = 25°C, after excursion of 250A		500	640	mA
Offset Current	I _{OE}	T _A = 25°C			1.25	A
Linearity Error	E _{LIN}	Full scale of I _P	-1	0.5	1	%
Total Output Error	E _{TOT, H}	Full scale of I _P , T _A = 25 to 85°C	-2		2	%
	E _{TOT, L}	Full scale of I _P , T _A = -40 to 25°C	-2		2	%

SYCT250UF-3 Performance Characteristics

 (V_{CC} = 3.3V, C_{VCC} = 0.1μF, T_A = -40 to 85°C, unless otherwise specified)

Parameter	Symbol	Condition	Min	Typ.	Max	Unit
Nominal Performance						
Current Sensing Range	I _P		0		250	A
Sensitivity	Sens			9.9		mV/A
Accuracy Performance						
Sensitivity Error	E _{SENS}	T _A =25°C	-1		1	%
Voltage Offset Error	V _{OE}	I _P =0A, T _A = 25°C	-4	±3	4	mV
		I _P =0A	-20	±8	20	mV
Magnetic Offset Error	I _{OM}	I _P =0A, T _A = 25°C, after excursion of 250A		250	320	mA
Offset Current	I _{OE}	T _A = 25°C			0.65	A
Linearity Error	E _{LIN}	Full scale of I _P	-1	0.5	1	%
Total Output Error	E _{TOT, H}	Full scale of I _P , T _A = 25 to 85°C	-2		2	%
	E _{TOT, L}	Full scale of I _P , T _A = -40 to 25°C	-2		2	%

Operation

The SYCT-3 is a family of high accuracy galvanically isolated current sensor ICs. There are various output modes for measuring bidirectional or unidirectional current from 50A to 250A, which output the analog voltage proportional to the AC or DC current. The bandwidth is up to 170kHz.

A precise, proportional output voltage is achieved by the high accuracy Hall IC, which is trimmed for accuracy at the factory.

The package offers four options, PFF/PSF/PSS/SMT, for easy implementation, which the PFF is the standard package.

Application Information

Sensitivity (Sens)

Sensitivity is the slope of the approximate straight line between the output voltage (V_{OUT}) and the input primary current (I_P) within the sensing range. V_{QVO} is the quiescent voltage output.

$$V_{OUT} = V_{QVO} + Sens \times I_P$$

Sensitivity Error (E_{SENS})

The sensitivity error (E_{SENS}) is the percent difference between the measured sensitivity ($Sens_M$) and the ideal value ($Sens_{TYP}$).

$$E_{SENS} = \frac{Sens_M - Sens_{TYP}}{Sens_{TYP}} \times 100 (\%)$$

Response Time (t_{RES})

Response time (t_{RES}) is defined as the time delay from the 90% of input primary current (I_P) to the 90% of the output voltage (V_{OUT}).

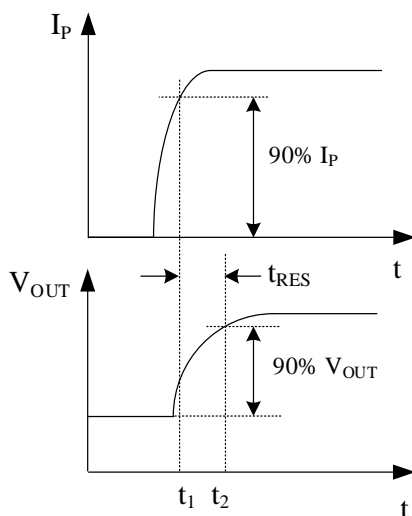

Figure 3. Response Time

Quiescent Voltage Output (V_{QVO})

The V_{QVO} is defined as the output voltage (V_{OUT}) when the primary current (I_P) is zero. It is related to V_{CC} , current direction, and internal logic. The relationship is shown as below, where xxx represents the sensing range (050/100/150/200/250):

Part Number	V_{QVO}
SYCTxxxBR-3	$V_{CC}/2$
SYCTxxxBF-3	1.65V
SYCTxxxUF-3	0.50V

Voltage Offset Error (V_{OE})

The voltage offset error (V_{OE}) is defined as the deviation of the zero current output voltage from its ideal quiescent value (V_{QVO}), due to nonmagnetic causes.

Zero Current Output Ratiometric Error (E_{RAT})

When the supply voltage V_{CC} changes from the typical value ($V_{CC, TYP}$) to $V_{CC, MIN} < V_{CC, M} < V_{CC, MAX}$ there will be a certain deviation between the measured zero current output ($V_{QVO, M}$) and its ideal value ($V_{QVO, TYP}$). The relationship is shown as below:

$$E_{RAT} = 1 - \frac{V_{QVO, M}}{V_{CC, M}} \times \frac{V_{CC, TYP}}{V_{QVO, TYP}}$$

Magnetic Offset Error (I_{OM})

The magnetic offset is due to the remnant field of the core material. The magnetic offset error is highest when the primary current approaches zero from the maximum value.

Linearity Error (E_{LIN})

The linearity error (E_{LIN}) is the maximum positive or negative error between the measured output voltage and the ideal value within the sensing range.

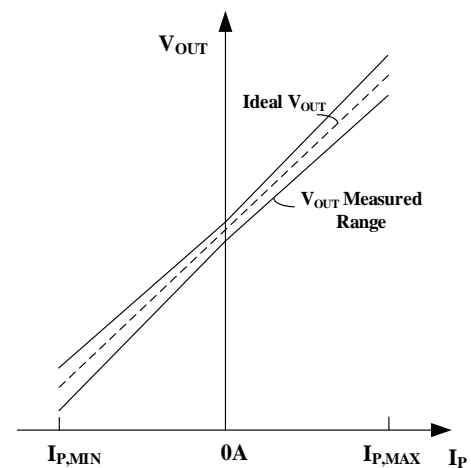

Figure 4. Linearity Error

Total Output Error (E_{TOT})

Total output error (E_{TOT}) is defined as the difference between the ideal output voltage (V_{OUT}) and the actual output voltage ($V_{OUT,IP}$), divided by the ideal sensitivity ($Sens$), relative to the primary current (I_P) flowing through the primary conduction path:

$$E_{TOT} = \frac{V_{OUT,IP} - V_{OUT}}{Sens \times I_P}$$

At relatively high current, E_{TOT} will be mostly due to sensitivity errors; but at relatively low current, E_{TOT} will be mostly due to the voltage offset error (V_{OE}). As the primary current (I_P) approaches zero, the E_{TOT} approaches infinity due to the voltage offset error (V_{OE}).

Layout Design

The layout design of the SYCT-3 is relatively simple. For the best performance, the attention should be paid to heat dissipation and traces.

1. It is best practice for the current to approach the IC parallel to the current-carrying pins, and for the current-carrying trace to not creep towards the center of the package.
2. It is best to place C_{VCC} and C_L close to the IC to achieve better filtering performance.

Package outline & PCB Layout Design

Standard (PFF) Package

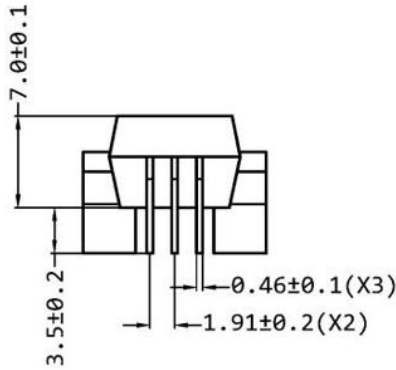

Side View

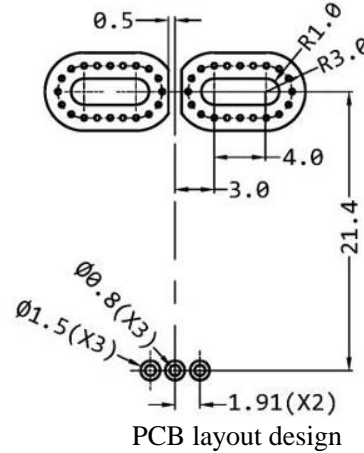

PCB layout design

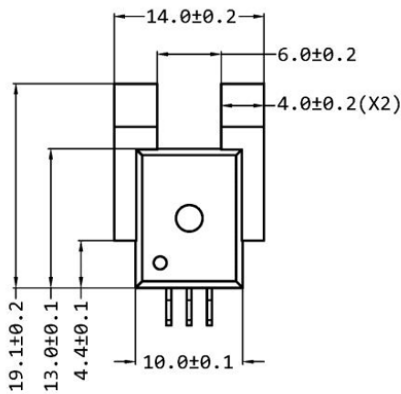

Top View

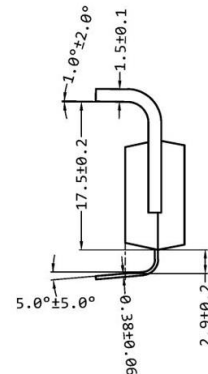

Side View

Terminals	Definitions
1	Vcc
2	GND
3	Vout
4	IP+
5	IP-

Notes: All dimensions are in millimeters.
All dimensions don't include mold flash & metal burr.

PSF Package

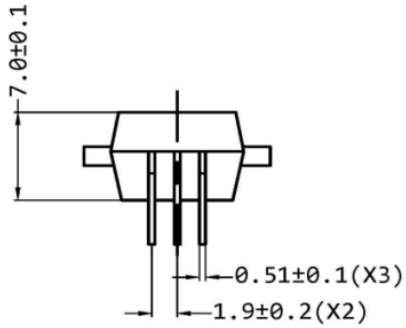

Side View

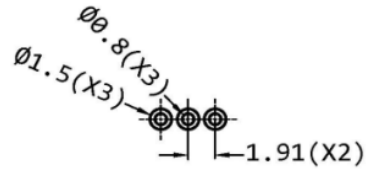

PCB layout design

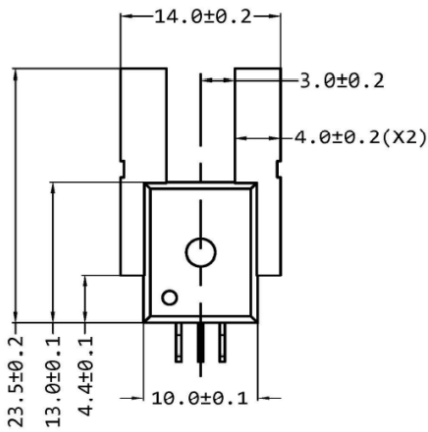

Top View

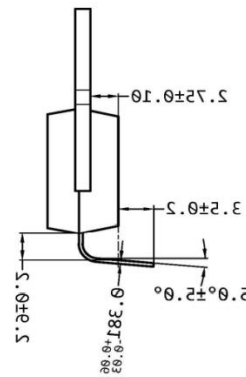

Side View

Terminals	Definitions
1	Vcc
2	GND
3	Vout
4	IP+
5	IP-

Notes: All dimensions are in millimeters.
All dimensions don't include mold flash & metal burr.

PSS Package

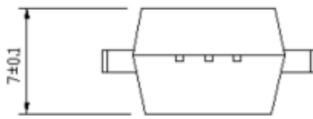

Side View

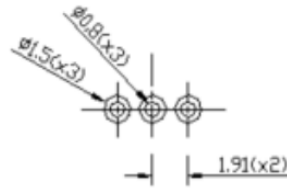

PCB layout design

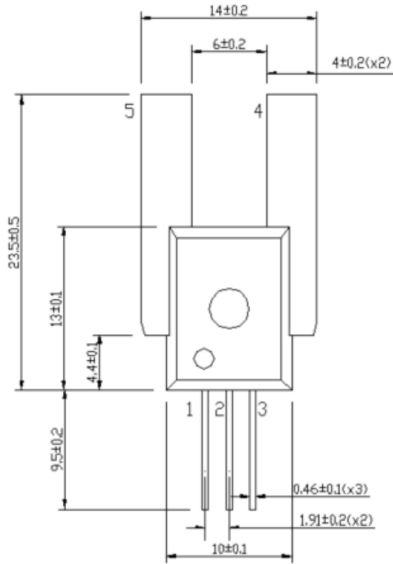

Top View

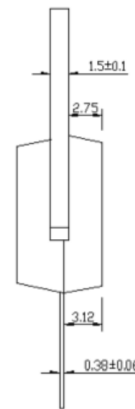

Side View

Terminals	Definitions
1	VCC
2	GND
3	VOUT
4	IP+
5	IP-

Notes: All dimensions are in millimeters.
All dimensions don't include mold flash & metal burr.

SMT Package

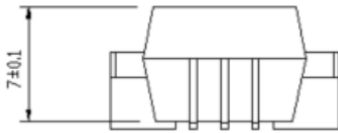

Side View

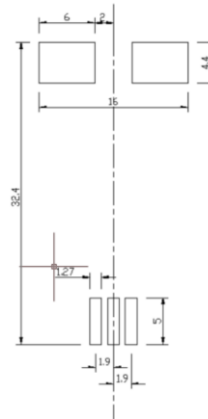

PCB layout design

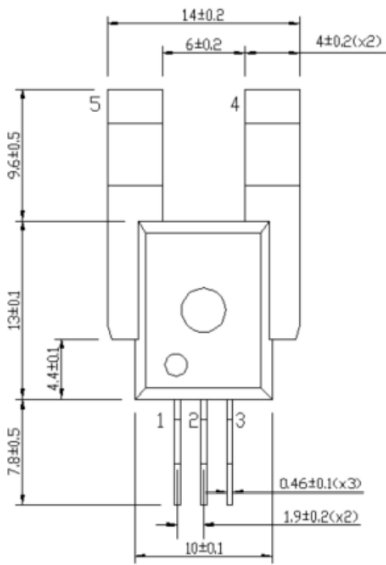

Top View

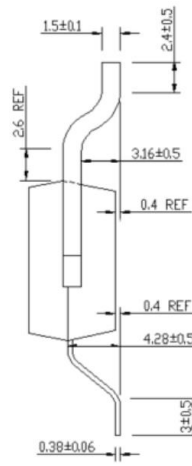

Side View

Terminals	Definitions
1	VCC
2	GND
3	VOUT
4	IP+
5	IP-

Notes: All dimensions are in millimeters.
All dimensions don't include mold flash & metal burr.

IMPORTANT NOTICE

- 1. Right to make changes.** Silergy and its subsidiaries (hereafter Silergy) reserve the right to change any information published in this document, including but not limited to circuitry, specification and/or product design, manufacturing or descriptions, at any time and without notice. This document supersedes and replaces all information supplied prior to the publication hereof. Buyers should obtain the latest relevant information before placing orders and should verify that such information is current and complete. All semiconductor products are sold subject to Silergy's standard terms and conditions of sale.
- 2. Applications.** Application examples that are described herein for any of these products are for illustrative purposes only. Silergy makes no representation or warranty that such applications will be suitable for the specified use without further testing or modification. Buyers are responsible for the design and operation of their applications and products using Silergy products. Silergy or its subsidiaries assume no liability for any application assistance or designs of customer products. It is customer's sole responsibility to determine whether the Silergy product is suitable and fit for the customer's applications and products planned. To minimize the risks associated with customer's products and applications, customer should provide adequate design and operating safeguards. Customer represents and agrees that it has all the necessary expertise to create and implement safeguards which anticipate dangerous consequences of failures, monitor failures and their consequences, lessen the likelihood of failures that might cause harm and take appropriate remedial actions. Silergy assumes no liability related to any default, damage, costs or problem in the customer's applications or products, or the application or use by customer's third-party buyers. Customer will fully indemnify Silergy, its subsidiaries, and their representatives against any damages arising out of the use of any Silergy components in safety-critical applications. It is also buyers' sole responsibility to warrant and guarantee that any intellectual property rights of a third party are not infringed upon when integrating Silergy products into any application. Silergy assumes no responsibility for any said applications or for any use of any circuitry other than circuitry entirely embodied in a Silergy product.
- 3. Limited warranty and liability.** Information furnished by Silergy in this document is believed to be accurate and reliable. However, Silergy makes no representation or warranty, expressed or implied, as to the accuracy or completeness of such information and shall have no liability for the consequences of use of such information. In no event shall Silergy be liable for any indirect, incidental, punitive, special or consequential damages, including but not limited to lost profits, lost savings, business interruption, costs related to the removal or replacement of any products or rework charges, whether or not such damages are based on tort or negligence, warranty, breach of contract or any other legal theory. Notwithstanding any damages that customer might incur for any reason whatsoever, Silergy' aggregate and cumulative liability towards customer for the products described herein shall be limited in accordance with the Standard Terms and Conditions of Sale of Silergy.
- 4. Suitability for use.** Customer acknowledges and agrees that it is solely responsible for compliance with all legal, regulatory and safety-related requirements concerning its products, and any use of Silergy components in its applications, notwithstanding any applications-related information or support that may be provided by Silergy. Silergy products are not designed, authorized or warranted to be suitable for use in life support, life-critical or safety-critical systems or equipment, nor in applications where failure or malfunction of a Silergy product can reasonably be expected to result in personal injury, death or severe property or environmental damage. Silergy assumes no liability for inclusion and/or use of Silergy products in such equipment or applications and therefore such inclusion and/or use is at the customer's own risk.
- 5. Terms and conditions of commercial sale.** Silergy products are sold subject to the standard terms and conditions of commercial sale, as published at <http://www.silergy.com>, unless otherwise agreed in a valid written individual agreement specifically agreed to in writing by an authorized officer of Silergy. In case an individual agreement is concluded only the terms and conditions of the respective agreement shall apply. Silergy hereby expressly objects to and denies the application of any customer's general terms and conditions with regard to the purchase of Silergy products by the customer.
- 6. No offer to sell or license.** Nothing in this document may be interpreted or construed as an offer to sell products that is open for acceptance or the grant, conveyance or implication of any license under any copyrights, patents or other industrial or intellectual property rights. Silergy makes no representation or warranty that any license, either express or implied, is granted under any patent right, copyright, mask work right, or other intellectual property right. Information published by Silergy regarding third-party products or services does not constitute a license to use such products or services or a warranty or endorsement thereof. Use of such information may require a license from a third party under the patents or other intellectual property of the third party, or a license from Silergy under the patents or other intellectual property of Silergy.

For more information, please visit: www.silergy.com

© 2025 Silergy Corp.

All Rights Reserved.