

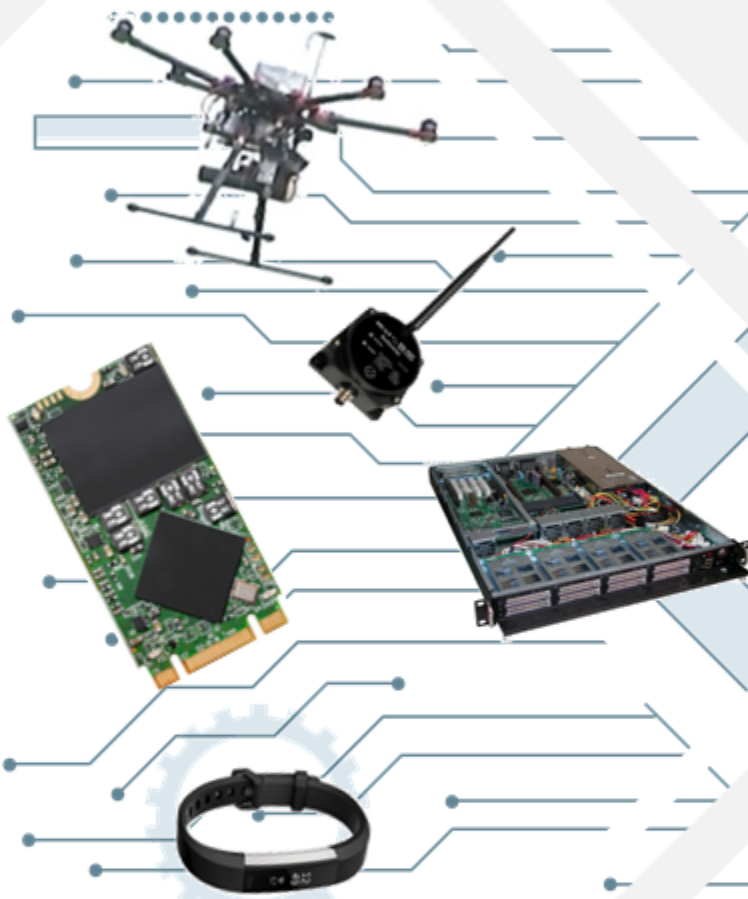

SILERGY

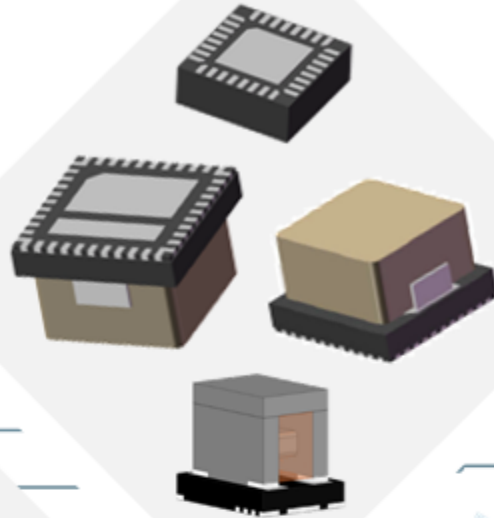

Power Module

SILERGY – *POWERING THE FUTURE*

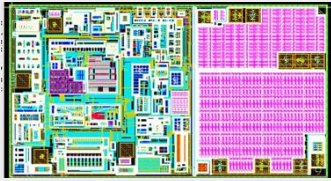

IC Design

- ✓ Advanced Single Die solution
- ✓ High efficiency topology
- ✓ High Frequency & low loss switch

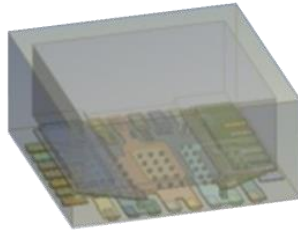

3D Package

- ✓ Patent 3D package tech
- ✓ Low Parasitic Parameter
- ✓ Excellent thermal design

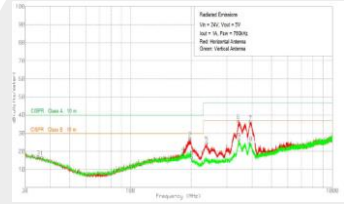

Mag. & EMI

- ✓ Customized Mag. Design
- ✓ New Material & process
- ✓ Low core & AC copper loss

Power Module Advantage

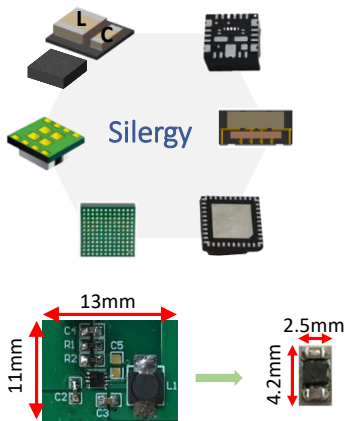

Space Saving

- ✓ Compared to Discrete, Up to 90% Size Reduction

High Performance

- ✓ Reduced Parasitic L/C Improving Efficiency and Minimize Signal Distortions
- ✓ Excellent Thermal & EMI Performance with 3D Package
- ✓ Good Anti-vibration and Environmental Ability

Low Total Cost

- ✓ PCB Cost Saving & SMD Process Time Saving
- ✓ Shorter Time to Market (Easy Layout, Fast Testing, Debug).
- ✓ Simpler Sourcing Management (Lower MOQ, Low CE & System job)

SQ76002B -- 5V input, 2A Module

Features:

- ✓ 2.5V to 5.5V input voltage range
- ✓ Capable of 2A constant output current
- ✓ Compact Package: MDFN1.9×1.75-6 (Height:1.08mm max)
- ✓ High Switching Frequency 2.4MHz Minimizes the External Components
- ✓ PFM Mode for Light Load Efficiency(90.6% Peak Efficiency @VIN=3.3V, VOUT=1.8V,TA=25° C)
- ✓ 100% Dropout Operation
- ✓ Power Good Indicator
- ✓ Reliable Protection Mode: Auto-retry Mode for OVP, UVLO and OTP. Hiccup Mode for OCP

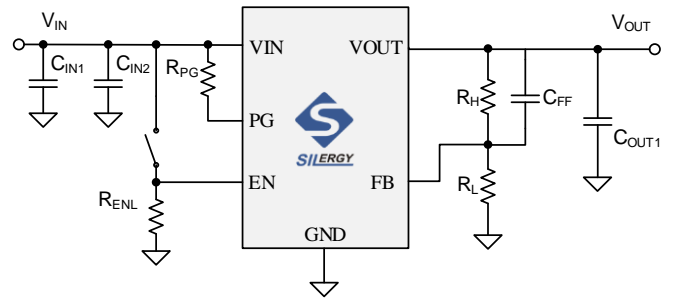

Typical Schematic

Efficiency@3.3V Input :

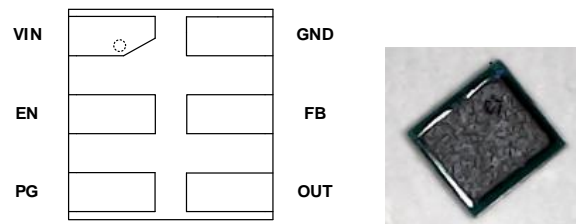
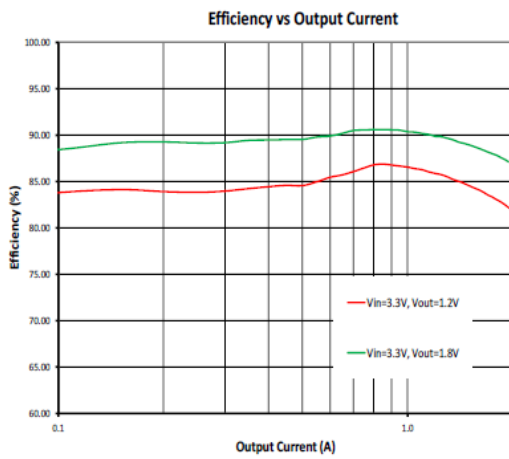

Package:MDFN1.9x1.75-6, Height: 1.08mm max

SQ76003D -- 6V input, 3A Module

Features:

- ✓ 2.5~6V input voltage range
- ✓ Adjustable output voltage
- ✓ Maximum current Capability: 3A
- ✓ 2.4MHZ switching Frequency
- ✓ Power good indicator
- ✓ Package:MQFN2.5x2-10, Height: 1.22mm max

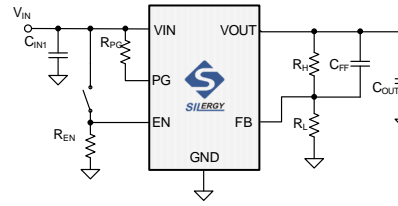

Typical Schematic

Competition:

P/N	Max I _{OUT} (A)	Package (mm)	Efficiency @ I _{OUT} =3.0A V _{IN} =3.3V, V _{OUT} =1.8V
SQ76003A	3.0A	3.0x3.0x1.1	86%
SQ76003D	3.0A	2.5x2x1.22	88.8%

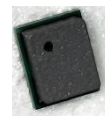
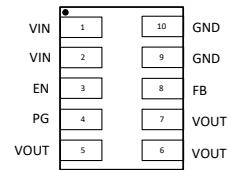

Package:MQFN2.5x2-10, Height: 1.22mm max

SQ76825D -- 5V input, 6A Module

Features:

- ✓ 2.7V to 5.5V input voltage range
- ✓ 6A continuous output current capability
- ✓ Programmable Output Voltage: 0.6V to 1.5V in 10mV steps
- ✓ Output Default Adjustable
- ✓ OCP/SCP/OVP/UVLO/OTP protections
- ✓ Power Good Indicator
- ✓ Tiny MQFN3x4-16 package (H: 1.8mm max)

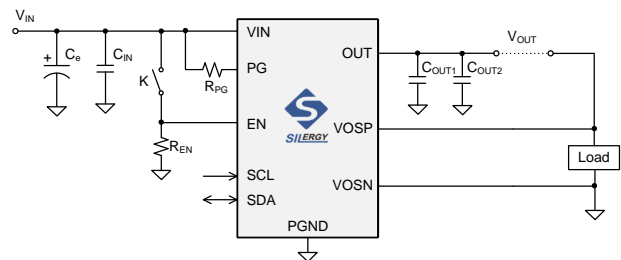

Typical Schematic

Efficiency@0.95V Output (PFM mode) :

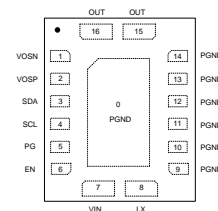
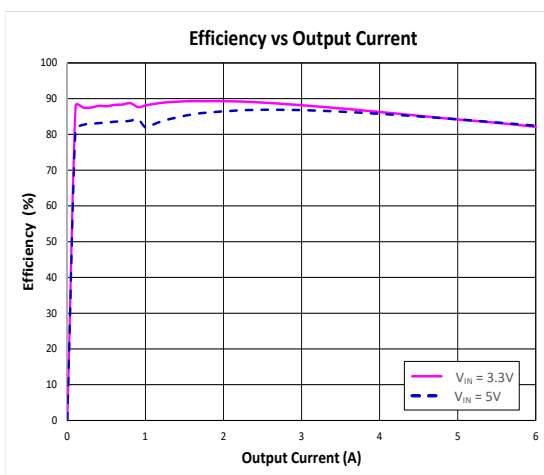

Package:MQFN3x4-16, Height: 1.8mm max

SQ76020– 5V input, 20A Module

Features:

- ✓ 2.75V to 5.5V input voltage range
- ✓ 20A maximum output current capability
- ✓ I²C programmable output voltages from 0.3V to 1.85V
- ✓ Output Default Adjustable
- ✓ COT control achieves fast transient performance
- ✓ OCP/SCP/OVP/UVLO/OTP protections
- ✓ Low output ripple & high efficiency with 4-phase Interleaved topology
- ✓ Package: MQFN5x6-24, Height: 1.8mm max

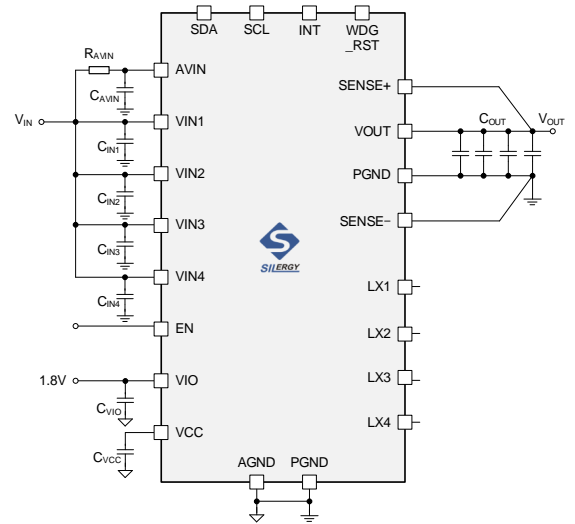

Typical Schematic

Efficiency@3.3V Input:

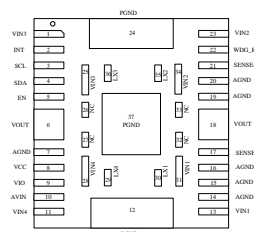
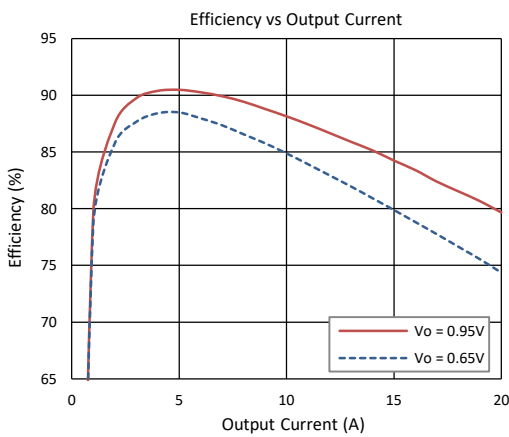

Package:MQFN5x6-24, Height: 1.8mm max

SQ76115B – 12V input, 15A Module

Features:

- ✓ 2.9~16V wide input voltage Range
- ✓ 15A continuous output current capability
- ✓ 600k/800k/1MHZ switching frequency selection
- ✓ High Reference Voltage Accuracy Over -40°C to 125°C
- ✓ Instant PWM architecture to achieve fast transient response
- ✓ Power good indicator
- ✓ OCP/UVP/UVLO/OTP
- ✓ Tiny MQFN5x5-32 package (H: 2.8mm max)

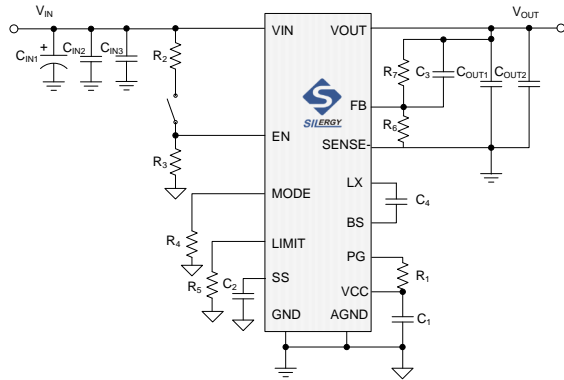

Typical Schematic

Efficiency@3.3V Output:

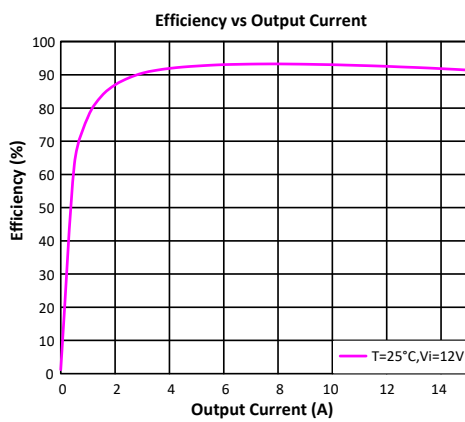

Package:MQFN5x5, Height: 2.8mm max

SQ76401A1 – 36V input, 1A Module

Features:

- ✓ 4.25~36V wide input voltage Range
- ✓ 1A continuous output current capability
- ✓ 2.1MHZ switching Frequency
- ✓ Low IQ Design
- ✓ Output Adjustable from 1V
- ✓ Power good indicator
- ✓ SCP/OCP/UVLO/OTP
- ✓ Tiny QFN3x2.5-10 package (Height : 1.75mm max)
- ✓ Recommended Junction Temperature : -40 °C ~125 °C

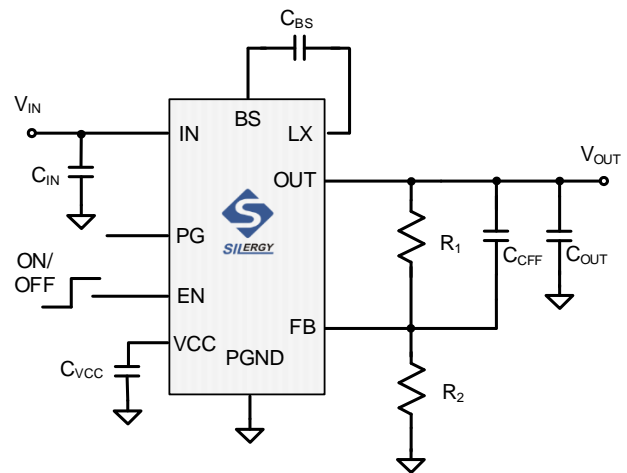

Typical Schematic

Efficiency@24V input:

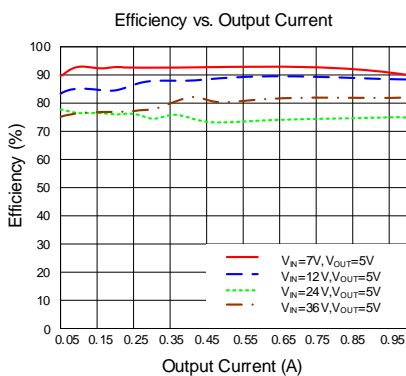

SQ74001 – 3.3V input, 1.5A Buck-Boost Module

Features:

- ✓ 2.65V to 5.5V input voltage range (3.3V typical value)
- ✓ Output voltage: 3.3V
- ✓ Max output current: 1.5A
- ✓ 1MHz working Frequency
- ✓ PFM/FCCM selectable
- ✓ Power good indicator
- ✓ OCP , SCP & OTP
- ✓ Compact package: MQFN3x2.1x1.12mm

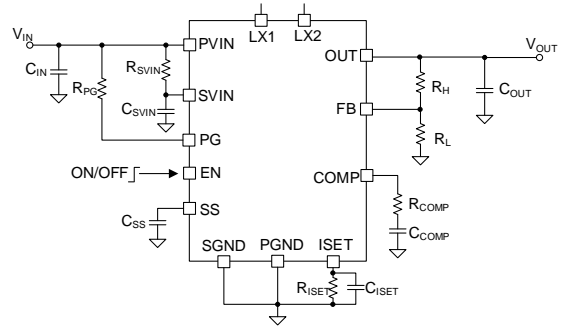

Typical Schematic

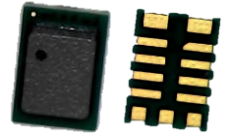
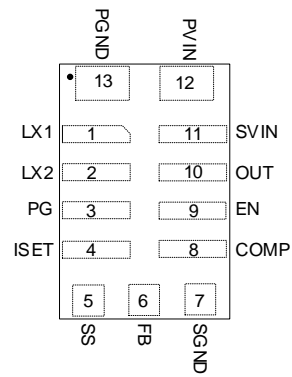
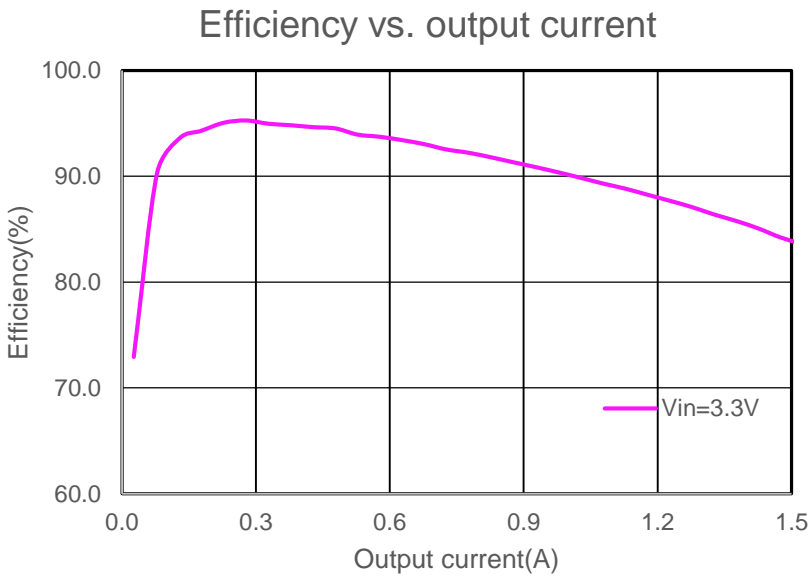

Package:MQFN3x2.1, Height: 1.12mm max

SQ79002 – 5-14V input,1W Isolation Module

Features:

- ✓ 4.5~14V wide input, 5V/1W output
- ✓ 3000Vdc Isolation
- ✓ Input UVLO /OTP/OCP/SCP
- ✓ 1% typical Load regulation
- ✓ Tiny QFN4*5.5-14 package (H: 4.55mm max)
- ✓ Working Temperature: -40 °C ~105 °C

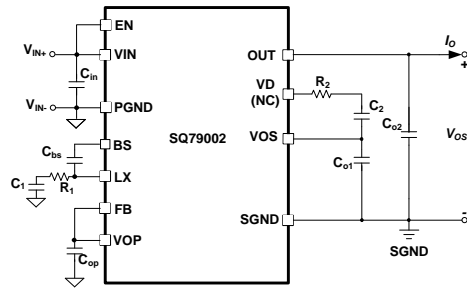

Typical Schematic



QFN4x5.5-14, H: 4.55mm max

Efficiency:

Efficiency vs. Output Current

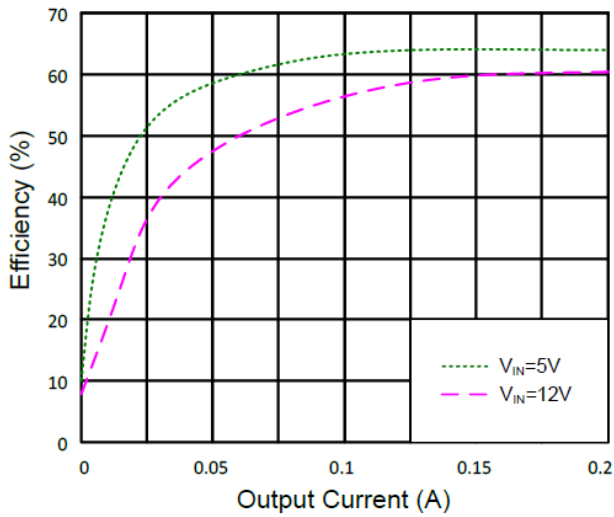

5V BUS Buck

Part Number	V _{IN} (Min) (V)	V _{IN} (Max) (V)	I _{OUT} (Max) (A)	F _{SW} (MHz)	Output Voltage (V)	V _{FB} Accuracy	Efficiency @ full load	Features	Package	Height (Max)(mm)	Sample Status
SQ76081QUC	2.5	5.5	0.6	3	Adjustable	±2%	80% @ 3.3V _{IN} , 1.8V _{OUT}	PFM	QFN2×1.5-8	1	MP
SQ76083QUC	1.8	5.5	0.6	3	Adjustable	±2%	83% @ 3.3V _{IN} , 1.8V _{OUT}	PFM, Low Iq	QFN2×1.5-8	1	MP
SQ76001RCC	2.5	5.5	1.2	3	Adjustable	±2%	79% @ 3.3V _{IN} , 1.8V _{OUT}	PFM	QFN2.5×2-8	1.15	MP
SQ76002AQNC	2.7	5.5	2	3	Adjustable	±1.5%	88.7% @ 3.3V _{IN} , 1.8V _{OUT}	PFM	QFN3×3-10	1.1	MP
SQ76002BAEE	2.5	5.5	2	2.4	Adjustable	±1.5%	87% @ 3.3V _{IN} , 1.8V _{OUT}	PFM	MDFN1.9×1.75-6	1.08	MP
SQ76003D1AAE	2.5	6	3	2.4	Adjustable	±1.5%	85% @ 3.3V _{IN} , 1.8V _{OUT}	FCCM	MDFN2.5X2-10	1.08	MP
SQ76003AQNC	2.7	5.5	3	3	Adjustable	±1.5%	86% @ 3.3V _{IN} , 1.8V _{OUT}	PFM	QFN3×3-10	1.1	MP
SQ76004BAKE	2.5	6	4	2.4	Adjustable	±1%	86% @ 3.3V _{IN} , 1.8V _{OUT}	FCCM	QFN2.5×2.5-10	1.22	2024/2/10
SQ76003DAAE	2.5	6	3	2.4	Adjustable	±1%	89% @ 3.3V _{IN} , 1.8V _{OUT}	FCCM	MDFN2.5×2-10	1.22	MP
SQ76003EAAE	2.5	6	3	2.4	Adjustable	±1%	88% @ 3.3V _{IN} , 1.8V _{OUT}	PFM	MDFN2.5×2-10	1.22	Sample available
SQ76004QNC	2.7	5.5	4	3	Adjustable	±1.5%	85% @ 3.3V _{IN} , 1.8V _{OUT}	PFM	QFN3×3-10	2.1	MP
SQ76825BABE	2.7	5.5	6	1.5	Adjustable, Default: 1V	±1%	83% @ 3.3V _{IN} , 1V _{OUT}	I ² C	MQFN3×4-16	1.8	2024/2/20
SQ76825DABE	2.7	5.5	6	1.5	Adjustable, Default: 0V	±1%	83% @ 3.3V _{IN} , 1V _{OUT}	I ² C	MQFN3×4-16	1.8	Sample available
SQ76020AFE	2.75	5.5	20	3.4	Adjustable, Default: 0V	±1%	79.8% @ 3.3V _{IN} , 0.95V _{OUT}	FCCM	MQFN5×6-24	1.8	Sample available

12V BUS Buck

Part Number	V _{IN} (Min) (V)	V _{IN} (Max) (V)	I _{OUT} (Max) (A)	F _{SW} (MHz)	Output Voltage (V)	V _{FB} Accuracy	Efficiency @ full load	Features	Package	Height (Max)(mm)	Sample Status
SQ76102ATRC	4.5	18	2	1	Adjustable	±1%	92% @ 12V _{IN} , 5V _{OUT}	FCCM	QFN3×3-7	2.1	MP
SQ76103ATRC	4.5	18	3	1	Adjustable	±1%	91% @ 12V _{IN} , 5V _{OUT}	FCCM	QFN3×3-7	2.1	MP
SQ76103C1ACE	4.7	18	3	2	Adjustable	±1%	85% @ 12V _{IN} , 3.3V _{OUT}	FCCM	QFN3×2.8-8	1.5	MP
SQ76103D1ACE	4.7	15	3	2	Adjustable	±1%	85% @ 12V _{IN} , 3.3V _{OUT}	PFM	QFN3×2.8-8	1.5	MP
SQ76202QNC	4.5	23	2	1.7	Adjustable	±1.5%	83% @ 12V _{IN} , 3.3V _{OUT}	PFM	QFN3×3-10	2.1	MP
SQ76115BAJM	2.9	16	15	Adj	Adjustable	±1%	91.3% @ 12V _{IN} , 3.3V _{OUT}		MQFN5×5-32	2.8	MP
SQ76130BABG	4.5	16	30	Adj	Adjustable	±1%	84.4% @ 12V _{IN} , 1V _{OUT}	PFM/FCCM	MLGA7.1*8-34	3.9	2024/3/10

Power Block (DrMos + Inductor)

Part Number	V _{IN} (Min) (V)	V _{IN} (Max) (V)	I _{OUT} (Max) (A)	F _{SW} (MHz)	Output Voltage (V)	Efficiency @ full load	Package	Height (Max)(mm)	Sample Status
SQ75130AQM	5	16	30	Adjustable	Adjustable	86.8% @ 12V _{IN} , 1V _{OUT}	MLGA7×8-48	3.98	Sample available

HV BUS Buck

Part Number	V _{IN} (Min) (V)	V _{IN} (Max) (V)	I _{OUT} (Max) (A)	F _{SW} (MHz)	Output Voltage (V)	V _{FB} Accuracy	Efficiency @ full load	Features	Package	Height (Max)(mm)	Sample Status
SQ76401A1WHQ	4.25	36	1	2.1	Adjustable	±1%	82% @ 24V _{IN} , 5V _{OUT}	PFM	QFN3×2.5-10	1.75	Sample available
SQ76801AEM	7	90	1	Adj	Adjustable	±2%	83% @ 48V _{IN} , 5V _{OUT}	FCCM	MQFN5×5-11	3.7	MP

Non-isolated Module

Part Number	V _{IN} (Min) (V)	V _{IN} (Max) (V)	I _{OUT} (Max) (A)	F _{SW} (MHz)	Output Voltage (V)	V _{FB} Accuracy	Efficiency @ full load	Features	Package	Height (Max)(mm)	Sample Status
SQ74001AHE	2.65	5.5	1.5	1	3.3	±1.5%	83.6% @ 3.3V _{IN} , 3.3V _{OUT}	Buck/Boost	MQFN2.1×3-13	1.12	Sample available
SQ75001QNC	0.85	5.5	1	2	Adjustable	±1.5%	90% @ 3.3V _{IN} , 5V _{OUT}	Boost	QFN3×3-10	2.1	MP

Isolated Module

Part Number	V _{IN} (Min) (V)	V _{IN} (Max) (V)	I _{OUT} (Max) (A)	F _{SW} (MHz)	Output Voltage (V)	V _{FB} Accuracy	Efficiency @ full load	Features	Package	Height (Max)(mm)	Sample Status
SQ79002WNQ	4.5	14	0.2	1.6	5	-	65% @ 5V _{IN} , 5V _{OUT}	3kV DC Hipot	QFN4*5.5-14	4.55	MP