



# MAX78700

# Multichannel, Isolated, Precision ADC

## General Description

The MAX78700 is an isolated analog-to-digital converter (ADC) for use with a compatible MAX78xxx energy measurement processor. The device provides current and voltage measurements to the host while the host provides control, command, and power to the MAX78700. A pulse transformer provides the isolated data and power path between the device and host, eliminating the need for additional isolation components in the measurement subsystem.

## Applications

- Smart Grid-Friendly Equipment
- Lighting Control Systems
- Commercial and Industrial Automation
- Renewable Energy Systems
- Electric Vehicle Charging Systems

## Benefits and Features

- Better Than 0.5% Watt-Hour Accuracy Over Wide Dynamic Range Using a Single Calibration Point
- High-Resolution Delta-Sigma ADC
- Factory-Trimmed Voltage Reference and Die Temperature Sensor
- Simplified System Architecture
- No Power Supply Required
- Fully Powered by the Host with the Isolation Transformer
- Eliminates Data Isolation Components
- Reduced Form Factor and Bill of Materials
- Small 10-Pin  $\mu$ SOP Package

*Ordering Information appears at end of data sheet.*

## Block Diagram

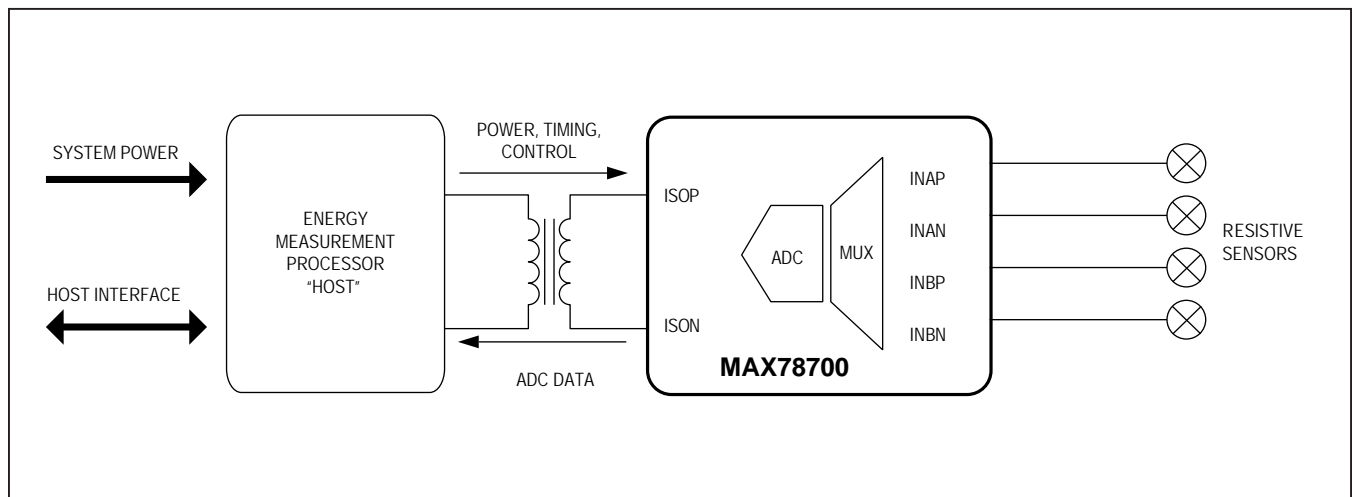

### Absolute Maximum Ratings

(All voltages with respect to GND.)

Voltage Range INAN, INAP, INBP, INBN .....-0.5V to +4.6V  
 Voltage Range ISOP, ISON.....-0.5V to +4.6V  
 Operating Temperature Range..... -40°C to +85°C  
 Operating Junction Temperature (Peak) ..... +140°C

Operating Junction Temperature (Peak, 100ms) .....+140°C  
 Operating Junction Temperature (Continuous) .....+125°C  
 Storage Temperature..... -45°C to +165°C  
 Lead Temperature (soldering, 10s) .....+300°C  
 Soldering Temperature (reflow) .....+260°C

*Stresses beyond those listed under "Absolute Maximum Ratings" may cause permanent damage to the device. These are stress ratings only, and functional operation of the device at these or any other conditions beyond those indicated in the operational sections of the specifications is not implied. Exposure to absolute maximum rating conditions for extended periods may affect device reliability.*

### Recommended External Components

NAME	FROM	TO	FUNCTION	VALUE	UNIT
C1	V <sub>CC</sub>	GND	Bypass capacitor for supply	0.5	μF

### Performance Specifications

(Limits are 100% production tested at T<sub>A</sub> = +22°C. Limits over the operating temperature range and relevant supply voltage range are guaranteed by design and characterization.)

PARAMETER	SYMBOL	CONDITIONS	MIN	TYP	MAX	UNITS
Usable Input Range	V <sub>IN</sub>	INAP, INAN, INBP, INBN	V <sub>CC</sub> - 250		V <sub>CC</sub> + 250	mV peak
Total Harmonic Distortion	THD	First 10 harmonics, f <sub>IN</sub> = 65Hz, V <sub>IN</sub> = 20mV, 64kpts FFT, Blackman-Harris window		-85		dB
Input Impedance		f <sub>IN</sub> = 65Hz	20		90	k
Temperature Coefficient of Input Impedance		f <sub>IN</sub> = 65Hz (Note 1)		1.7		/°C
ADC Gain Error vs. % Power-Supply Variation		$\frac{10^6 \Delta N_{outPK} 357nV / V_{IN}}{100 \Delta V_{CC} / 3.3}$ V <sub>IN</sub> = 200mV <sub>P-P</sub> , 65Hz, V <sub>CC</sub> = 3.0V, 3.6V		50		ppm/%
Input Offset			-10		+10	mV

**Note 1:** Guaranteed by design, not subject to test.

### Pin Configuration

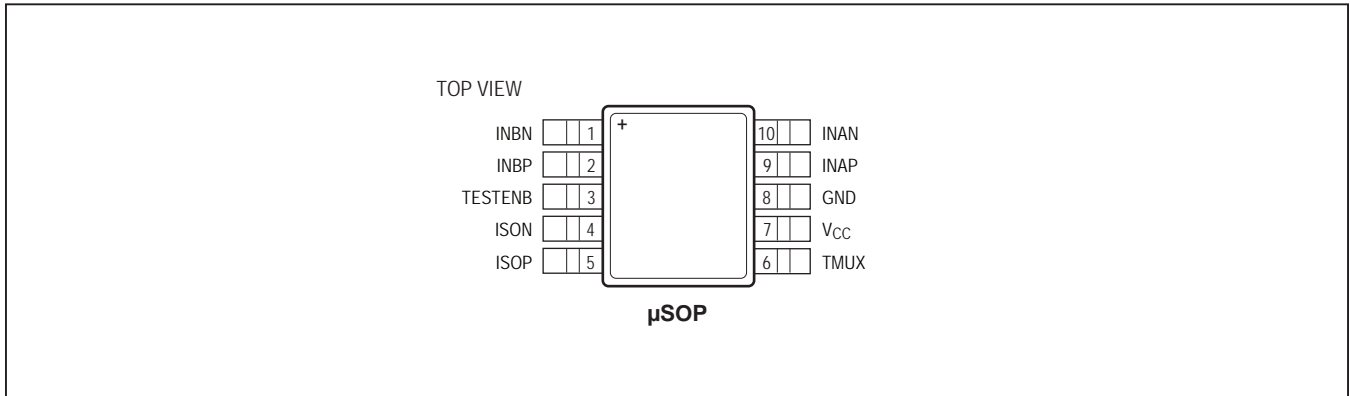

### Pin Description

PIN	NAME	FUNCTION
1	INBN	Channel B ADC Negative Input
2	INBP	Channel B ADC Positive Input
3	TESTENB	Enables the Test Modes. Must be grounded in normal operation.
4	ISON	Transformer Negative
5	ISOP	Transformer Positive
6	TMUX	Host-Controlled DIO
7	V <sub>CC</sub>	Output of the Rectifier Block
8	GND	Ground. The 0.5μF capacitor from V <sub>CC</sub> to GND must be connected to this pin.
9	INAP	Channel A ADC Positive Input
10	INAN	Channel A ADC Negative Input

### Detailed Description

The MAX78700 is an isolated current and voltage analog-to-digital converter (ADC) that is compatible with MAX78xxx hosts. The device digitizes low-level signals from shunt resistor type current sensors and resistive divider voltage measurements.

The device continuously sends ADC data to the host. The host can request the device to return certain ancillary data such as trim information and die temperature data. The MAX78700 communicates with the host through a pulse transformer to provide isolation from the high-voltage power domain.

Figure 1 shows a block diagram of the device with a brief description of various functional blocks.

#### Rectifier

The active rectifier in the device rectifies the power pulses received from the host through the isolation transformer to create the  $V_{CC}$  voltage. A 2.5V regulator block powers all the digital blocks of the chip except the PLL and ISO\_INT, which are powered by  $V_{CC}$ .

#### ISO\_INT

The isolated interface block receives the incoming data from the host and transmits data back to the host through the isolation transformer.

#### PLL

The PLL locks to the incoming power pulses to create reference clocks for the ADC and communications interface to the host.

#### ADC

A proven Teridian delta-sigma ADC digitizes the voltage and current-sense voltages.

#### Bandgap

The device includes an on-chip precision bandgap voltage reference that incorporates auto-zero techniques as well as production trims to minimize errors caused by component mismatch and drift. The result is a voltage output with a predictable temperature coefficient that is compensated in firmware by the host.

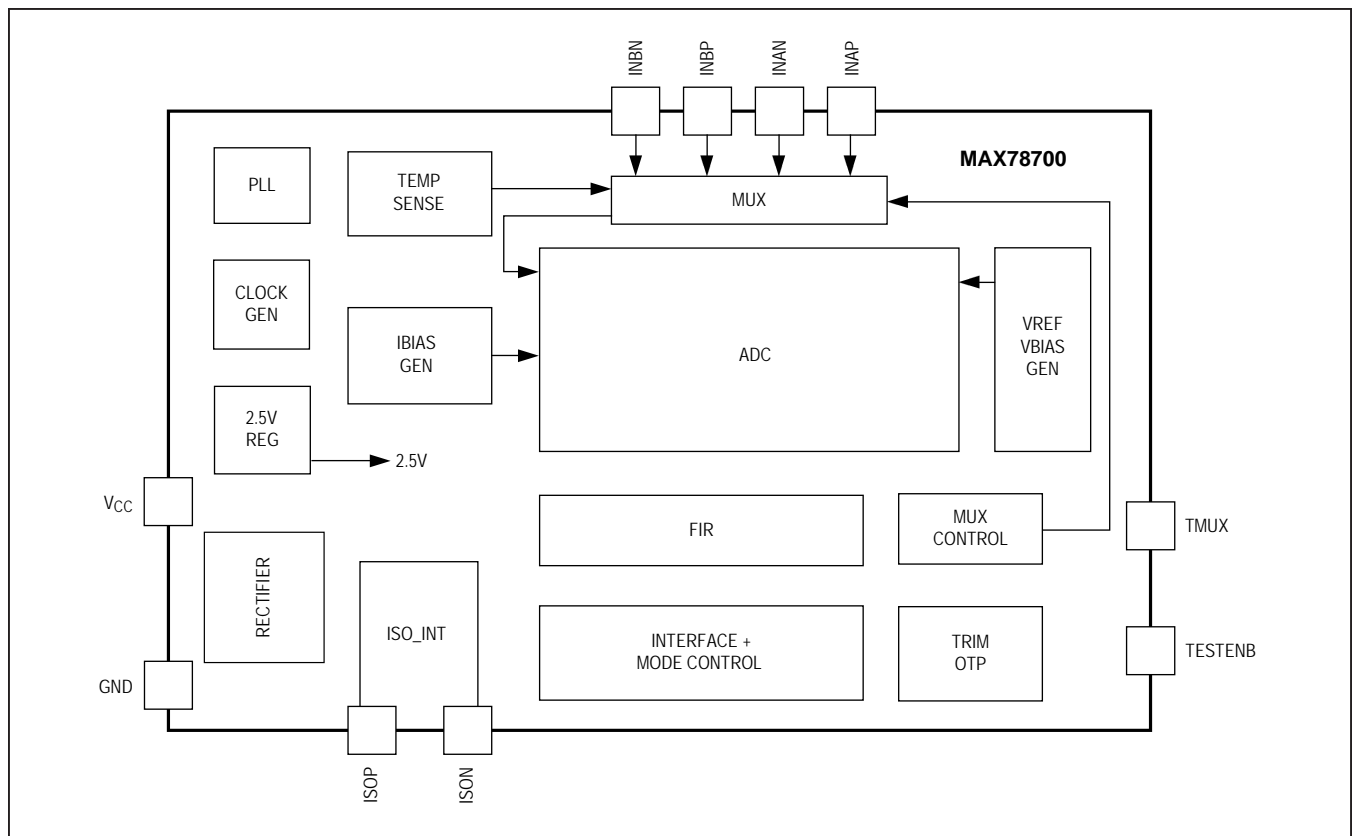

Figure 1. Functional Diagram

**Temperature and Power-Supply Voltage Measurement**

The device includes an on-chip temperature sensor. The voltage from this sensor is measured by the ADC and sent to the host. During manufacturing test, the circuit is calibrated by measuring the voltage at room temperature and storing the value in the OTP memory.

A resistor-divider scales the rectified power-supply voltage,  $V_{CC}$ , to match the input range of the ADC. The ADC measures the scaled voltage and the value is sent to the host.

**Ordering Information**

PART	TEMP RANGE	PIN-PACKAGE
MAX78700+A00	-40°C to +85°C	10 $\mu$ SOP
MAX78700+A00T	-40°C to +85°C	10 $\mu$ SOP

+Denotes a lead(Pb)-free/RoHS-compliant package.

T = Tape and reel.

**Package Information**

Package outline information is appended to this document. Land patterns (footprints) are inserted below.

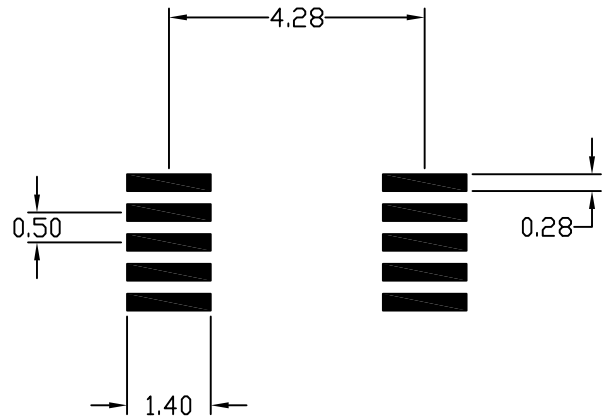

NOTES:

1. ALL DIMENSIONS IN MM.
2. LAND PATTERN COMPLIES TO: IPC7351A.
3. TOLFRANCF: +/- 0.02 MM.

## Revision History

REVISION NUMBER	REVISION DATE	DESCRIPTION	PAGES CHANGED
0	12/12	Initial release	—
1	4/16	Rebranding only	

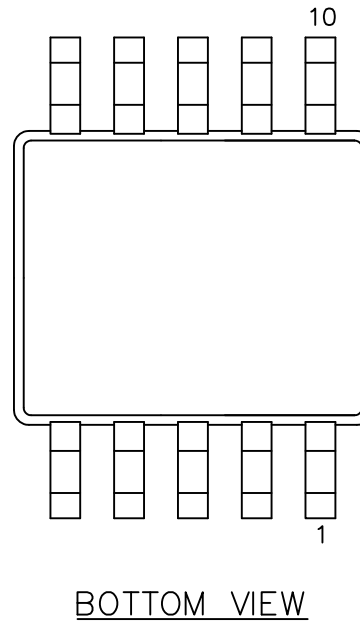
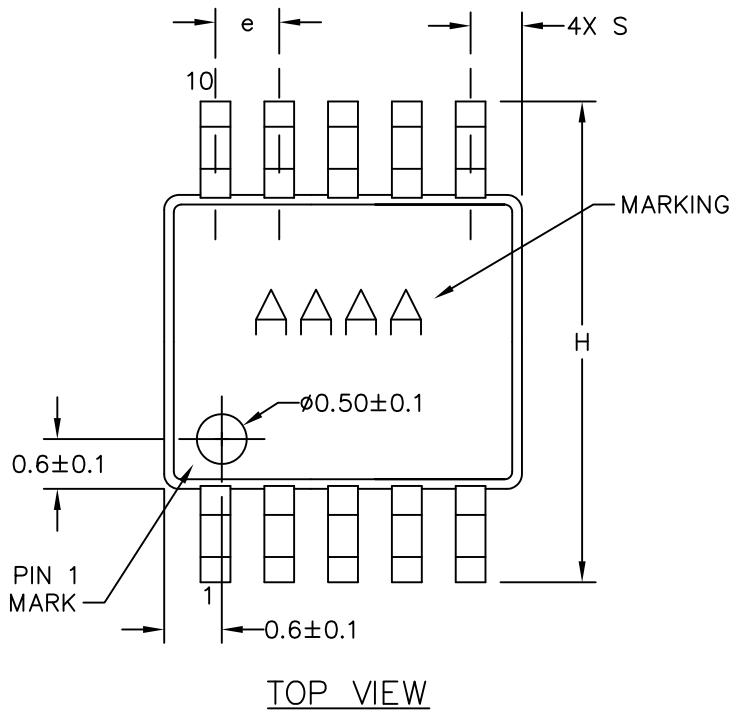

DIM	INCHES		MILLIMETERS	
	MIN	MAX	MIN	MAX
A	—	0.043	—	1.10
A1	0.002	0.006	0.05	0.15
A2	0.030	0.037	0.75	0.95
D1	0.116	0.120	2.95	3.05
D2	0.114	0.118	2.89	3.00
E1	0.116	0.120	2.95	3.05
E2	0.114	0.118	2.89	3.00
H	0.187	0.199	4.75	5.05
L	0.0157	0.0275	0.40	0.70
L1	0.037 REF		0.940 REF	
b	0.007	0.0106	0.177	0.270
e	0.0197 BSC		0.500 BSC	
c	0.0035	0.0078	0.090	0.200
S	0.0196 REF		0.498 REF	
$\alpha$	0°	6°	0°	6°

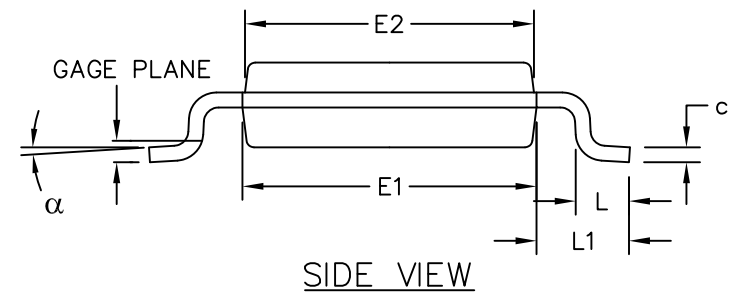
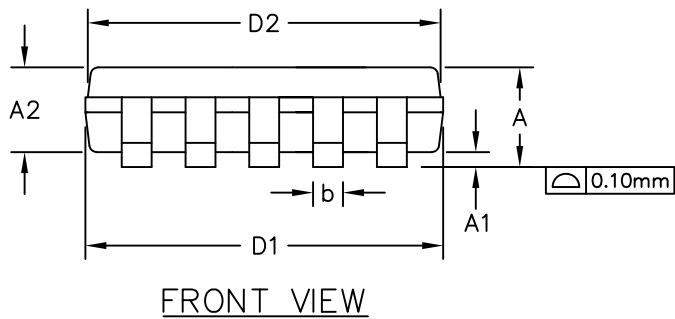

NOTES:

1. D&E DO NOT INCLUDE MOLD FLASH.
2. MOLD FLASH OR PROTRUSIONS NOT TO EXCEED 0.15mm (.006").
3. CONTROLLING DIMENSION: MILLIMETERS.
4. COMPLIES TO JEDEC MO-187, LATEST REVISION, VARIATION BA.
5. MARKING SHOWN IS FOR PKG. ORIENTATION ONLY.